

RESOLUTION

WHEREAS the Government of Barbados acknowledges that increased consumption, construction and other development activities has resulted in increased rates of waste and recyclable generation;

AND WHEREAS the Government of Barbados affirms its continuing commitment to undertake a number of initiatives to improve solid waste collection, disposal and management to better serve residents and visitors;

AND WHEREAS the Government of Barbados undertook a Route Optimisation Study for Solid Waste Collection for Barbados as part of the policy development component of the Integrated Solid Waste Management Programme to provide relevant and reliable data with respect to municipal, industrial, commercial and institutional waste to make the process of waste collection more efficient;

AND WHEREAS the Route Optimisation Study for Solid Waste Collection for Barbados focused on an analysis of the strategic approach taken by the Sanitation Service Authority and a comparative analysis of the business model for solid waste management in Barbados;

AND WHEREAS the Route Optimisation Study for Solid Waste Collection for Barbados was aimed at analysing the transport systems implemented by the Sanitation Service Authority including a collection service level assessment as well as a collection costing analysis and an evaluation of the existing fleet utilised by the Sanitation Service Authority, focusing on its size, capacity, age, road worthiness and overall ability to service communities;

AND WHEREAS the Route Optimisation Study for Solid Waste Collection for Barbados was undertaken by the Project Management Coordinating Unit and the Inter-American Development Bank, it was formally completed in May 2016.

BE IT RESOLVED that the Parliament of Barbados:

1. Accepts the Route Optimisation Study for Solid Waste Collection for Barbados as a national information document;
2. Agrees that the Route Optimisation Study for Solid Waste Collection for Barbados be made available to the public of

Barbados through the National Library Service and the online platform of the Government Information Service;

3. Lauds the efforts of the various stakeholders engaged in the production of the Route Optimisation Study for Solid Waste Collection for Barbados;
4. Reminds Barbadians of the importance of continuing to be good stewards of the country's natural environment; and
5. Reaffirms its commitment to ensure Barbados remains on a path of sustainable development and make informed decisions regarding solid waste management practices.

APPROVED by the House of Assembly this day of October 2017

Speaker

APPROVED by the Senate this day of October 2017.

President

2015 Joint Consulting with IOs
Consultancy for the Development of a Route Optimization
Study in Solid Waste Collection in Barbados

December 2015



Contents

Consultancy for the Development of a Route Optimization Study in Solid Waste Collection in Barbados

List of Abbreviations	1
Summary	3
I. Project Overview	4
1. Project Background and Objectives	4
2. Scope of Works	5
3. Expected Results.....	12
II. Analysis of Current Status	13
1. Law and Policy in Barbados	13
2. Current Status of Solid Waste Collection in Barbados	17
3. Problems and Issues.....	25
III. Case Study on Korea’s Experiences	27
1. Korean Waste Management Laws and Policies	27
2. General Status of Waste in Korea	40
3. Case Studies in Korea.....	48
IV. Recommendation	62
1. Recommendation for Number of Operational Trucks.....	62
2. Recommendations for Waste Management	73
3. Economic Feasibility Analysis	80
V. Conclusions and Suggestions	89
References	90

List of Tables

Table I-1. Stages of Execution	6
Table I-2. Consortium Members	10
Table I-3. Roles and Responsibilities of Consultants	11
Table II-1. Summary of ISWMP	16
Table II-2. Waste received by SBRC for the last 5 years (in tons)	18
Table II-3. Composition of Waste (2015)	19
Table II-4. Waste Collection by Region (2014)	22
Table II-5. Comparison of Barbados and Seoul	23
Table II-6. Defect Ratio of Equipment	25
Table II-7. Troublesome Issues related to Waste Collection	26
Table III-1. Main Waste Law.....	30
Table III-2. Products Included in EPR	35
Table III-3. Waste Disposal Companies	45
Table III-4. Waste Disposal Facilities by municipalities	45
Table III-5. Residential Waste Manpower and Equipment	46
Table III-6. 2013 Residential Waste Expenditures	47
Table III-7. 2014 Residential Waste Budget	47
Table III-8. Residential Waste Collection and Management Infrastructure in Seoul.....	55
Table III-9. Waste Generation and Treatment in Busan	56
Table III-10. Residential Waste Collection and Management Infrastructure in Busan.....	57
Table IV-1. General MHT Dependent on Type of Container & Location of Collection.....	62
Table IV-2. MHT Values for Collection Services	63
Table IV-3. Time-Motion Study Dependent on Type of Container	64
Table IV-4. Analysis of Time-Motion Study in Barbados	68
Table IV-5. Time Required to Collect One Ton of Waste by Bin Type.....	69
Table IV-6. Step 2 – Determining the Total Collection Weight	71

Table IV-7. Step 3 – Calculating the Total Cost & Selecting the Truck Capacity and Quantity.....	72
Table IV-8. Defect Ratio of Collection Trucks	74
Table IV-9. Comparison of Collection Methods	74
Table IV-10. Inflation Rate in Barbados	81
Table IV-11. Yearly Costs (Future Value)	83
Table IV-12. Yearly Costs (Present Value)	83
Table IV-13. Yearly Benefits (Future Value).....	85
Table IV-14. Yearly Benefits (Present Value).....	86
Table IV-15. Results of Economic Feasibility Analysis	86
Table IV-16. Results of Sensitivity Analysis	87

List of Figures

Figure II-1. Organizational Chart of Solid Waste Management in Barbados	14
Figure II-2. Waste Storage On-Site	20
Figure II-3. Regions of Waste Collection	21
Figure II-4. Waste Collection Equipment	22
Figure II-5. Waste Processing in Barbados	24
Figure III-1. Development Trends in Korea's Waste Management Policies	38
Figure III-2. Classification Structure	41
Figure III-3. Waste Generation for the last 15 years	42
Figure III-4. Composition of Residential Waste	43
Figure III-5. Disposal of Residential Waste	44
Figure III-6. Automatic Pipeline Transport System	48
Figure III-7. Trash bins for the APTS	49
Figure III-8. Waste Information Management System (Allbaro)	50
Figure III-9. Plastic bins for medical waste with RFID tags	50
Figure III-10. Example of the GPS-based Tracking System	51
Figure III-11. Types of Trucks	52
Figure III-12. Trend in Waste Generation & Burial in Seoul	54
Figure III-13. Busan Eco-Friendly Energy Town	58
Figure III-14. Current Status of Metropolitan Landfill	59
Figure III-15. Plan for Future Theme Park	61
Figure IV-1. Time-Motion Study Routes	65
Figure IV-2. Parameters for the Time-Motion Study	67
Figure IV-3. Type of Roads	76
Figure IV-4. Suggestions on Improvements in Roads	76
Figure IV-5. Equipment for Street Cleaning	77
Figure IV-6. Waste-to-Energy Plant Process	79
Figure IV-7. Benefit-Cost Graph	87

List of Abbreviations

Abbreviation	Full Description
APTS	Automatic Pipeline Transport System
B/C	Benefit / Cost
BSDP	Barbados Sustainable Development Policy
BWC	Barbados Waste Code
C&D	Construction and Demolition
CI	Commercial and Institutional
EHD	Environmental Health Department
EIRR	Economic Internal Rate of Return
EPD	Environmental Protection Department
EPR	Extended Producer Responsibility
ERR	Economic Internal Return Rate
GCF	Green Climate Fund
GOB	Government of Barbados
GPS	Global Positioning System
GW	Green Waste
ICI	Industrial, Commercial and Institutional
IDB	Inter-American Development Bank
IRR	Internal Return Rate
ISWMP	Integrated Solid Waste Management Programme
KERC	Korea Environment & Resources Corporation
KEXIM	Export-Import Bank of Korea
KMOE	Ministry of Environment of Korea
KSP	Knowledge Sharing Program
KWEA	Korea Municipal Waste Engineering Association

LFG	LandFill Gas
MED	Ministry of Environment and Drainage
MHT	Man Hour per Tom
MSW	Municipal Solid Waste
NPV	Net Present Value
ODA	Official Direct Assistance
PAHO	Pan America Health Organization
PET	PolyEthylene Terephthalate
PMCU	Project Management Coordination Unit
R&S	Rock and Soil
RDF	Refuse Derived Fuel
RFID	Radio Frequency IDentification
SBRC	Sustainable Barbados Recycling Center
SLC	Sudokwon Sandfill Site Management Corporation of Korea
SRF	Solid Refuse Fuel
SSA	Sanitation Services Authority
WTO	World Trade Organization
4Rs	Reduce, Reuse, Recycle, Recovery

Summary

Increased consumption, construction and other development activities has resulted in increased rates of waste and recyclable generation in Barbados and Barbados is putting a lot of effort and resources in improving the collection, disposal and management of solid waste in order to better serve residents and visitors. The Ministry of Environment and Drainage (MED) of Barbados, Inter-American Development Bank (IDB) and Export-Import Bank of Korea (KEXIM) agreed to proceed with a KSP-IDB Joint Consulting Project to study route optimization and to determine the improvement points for the solid waste collection and management process in Barbados.

This report provides the details of the results of the Consulting Project called the “Consultancy for the Development of Route Optimization Study in Solid Waste Collection in Barbados”. During the first mission trip for the Project, the KSP Consultants conducted As-Is Analysis of the current status and environment of solid waste collection, disposal and management in Barbados. From the As-Is Analysis and analysis of case studies in Korea, the KSP Consultants determined improvement points for solid waste collection, disposal and management in Barbados in terms of process improvements, system improvements, and equipment improvements.

A Dissemination Seminar was conducted in Barbados with the key stakeholders in order to present the findings of the report and to discuss the improvement points in more detail. The Dissemination Seminar was attended by the representatives from the IDB, Project Management Coordination Unit (PMCU), Sanitation Services Authority (SSA) and Environmental Protection Agency. The suggestions and comments raised during the Dissemination Seminar were incorporated into the final report and presented during the Capacity Building Workshop (CBW) which was also held in Barbados. Representatives for nine (9) neighboring Caribbean countries were invited to attend the CBW to present their current status and future plans for solid waste collection and management in their respective countries as well as discuss future needs and plans for the whole Caribbean region.

I. Project Overview

1. Project Background and Objectives

1.1. Project Background

Since 2004, the Ministry of Strategy and Finance of Korea had been initiating and sponsoring the KSP (Knowledge Sharing Program) with the Export-Import Bank of Korea as its execution agency. Every year more than 10 KSP Consulting Projects are executed in various underdeveloped countries in diverse fields and industries where Korea's knowledge and experience in the diverse fields and industries are shared with the recipient countries in order to help the recipient countries leap-frog to the next level of advancement without going through the pains and mistakes that might arise through trial-and-error processes. The economies of the recipient countries will also be able to grow and prosper through the knowledge gained from the KSP Consulting Projects.

In Barbados, increased consumption, construction and other development activities had resulted in increased rates of waste and recyclable generation. In 2008, Barbados constructed the Sustainable Barbados Recycling Center (SBRC) to properly manage the collection and disposal of waste. Barbados is putting a lot of effort and resources into improving the collection, processing, disposal and management of solid waste in order to better serve residents and visitors. The Ministry of Environment and Drainage (MED), IDB and KEXIM agreed to proceed with a KSP-IDB Joint Consulting Project to study route optimization and to determine the improvement points for the solid waste collection process and systems in Barbados.

In 2014 Inter-American Development Bank (IDB) sponsored the Caribbean Conference on Solid Waste Management in Jamaica and the Conference was attended by the representatives from some countries in the Caribbean and Central America. Presentations were made by individual countries to explain the current status and future plans for solid waste management in their countries. To continue the practice, IDB and KEXIM (Export-Import Bank of Korea) agreed to conduct a similar conference in Barbados in 2015 as a

Capacity Building Workshop where representatives from some neighboring countries along with Barbados were able to present the current status and future plans for solid waste collection and management in their respective countries. In addition, IDB and KEXIM shared the results of this Consulting Project, including the Best Practices and case studies in Korea, with the representatives from the other neighboring countries who attended the Capacity Building Workshop in order for all participants to share ideas and direction for advancements in processes and systems related to solid waste collection in the region.

1.2. Project Objectives

The Consulting Project's main objective was to conduct a route optimization study for solid waste collection in Barbados. Currently in Barbados, there are a number of problems that are arising due to inefficient solid waste collection such as stacking of solid waste waiting to be picked up, illegal dumping of solid waste, and others. The Consulting Project proposed solutions and alternatives to solving the current problems and issues related to solid waste collection and management in order to make the solid waste collection and management activities more efficient and standardized.

2. Scope of Works

2.1. Main Areas of Focus

- Solid waste collection process is not a stand-alone process that can be analyzed and managed independently; therefore, recycling process and solid waste disposal process will be included in the overall analysis and study.
- Hazardous waste collection was not included in this study where "hazardous waste" is defined as 1) characteristic waste which are materials that are known or tested to exhibit one or more of the following four hazardous traits: ignitability, reactivity, corrosivity, and/or toxicity and 2) listed hazardous wastes which are materials specifically listed by regulatory authorities as a hazardous waste which are from non-specific sources, specific sources, or discarded chemical products.

- This study concentrated on residential waste with some consideration of commercial waste while industrial waste was not covered..

2.2. Project Implementation Plan

The Consulting Project was executed in four stages : Preparation and As-Is Analysis Stage, Case Study and Recommendation Stage, Dissemination Seminar Stage, and Capacity Building Workshop Stage.

Table I-1 | Stages of Execution

Stage	Duration	Activity	Deliverables
1	2015. 8. 1 ~ 10. 15	<ul style="list-style-type: none"> ● Preparation and As-Is Analysis Stage : Research of relevant materials : Preparation of Mission Trip : Finalization of Project Implementation Plan : Inception Mission to Barbados (Oct. 8 ~ Oct. 15) 	<ul style="list-style-type: none"> ● Inception Report/ Project Implementation Plan ● Mission Plan ● Mission Report
2	2015. 10. 16 ~ 11. 15	<ul style="list-style-type: none"> ● Case Study and Recommendations Stage : Study of Best Practices and case study of solid waste collection in Korea : Determination of improvement points and recommendations for solid waste collection in Barbados : Invitation of participants to Capacity Building Workshop in Barbados 	<ul style="list-style-type: none"> ● Interim Report
3	2015. 11.1 ~ 11.30	<ul style="list-style-type: none"> ● Dissemination Seminar Stage : Presentation of final finding of the study to all stakeholders in Barbados : Preparation of Workshop and mission trip : Execution of Seminar in Barbados (Nov. 16 ~ 18) 	<ul style="list-style-type: none"> ● Mission Plan ● Mission Report
4	2015. 12. 1 ~ 12. 30	<ul style="list-style-type: none"> ● Capacity Building Workshop Stage : Planning and preparation of Workshop : Execution of Workshop in Barbados (Dec. 7 ~ Dec. 11) 	<ul style="list-style-type: none"> ● Materials for Workshop ● Mission Plan ● Final Report

2.3. Detailed Activities

2.3.1. Preparation and As-Is Analysis Stage

The main purpose of the Preparation and As-Is Analysis Stage was to properly prepare for and efficiently execute the Inception Mission Trip such that the on-site activities could be executed effectively without missteps and the As-Is status and environment was properly researched and analyzed to meet all the requirements and expectations of the stakeholders.

The following activities were performed during this stage:

- Understanding the objective, scope, target and direction of consulting services,
- Identifying and defining the roles and responsibilities of all the stakeholders,
- Identifying and defining the roles and responsibilities of all project members,
- Preparation of draft Project Implementation Plan which will be the document to be used for discussion during initial conference call between Consultant, KEXIM, IDB, and PMCU (Project Management Coordination Unit) of the MED of Barbados,
- Defining the exact scope and requirements of all the stakeholders
- Preparation of revised Project Implementation Plan detailing the exact scope, activities, duration, deliverables, project management plan, resources to be deployed,
- Document-based analysis of the current status and environment in host country,
- Preparation of the Inception Mission Plan (to be delivered two weeks prior to the mission, tentatively on Aug. 13, 2015),
- Preparation and distribution of questionnaires (included in Mission Plan),
- Go on Inception Mission (Oct. 8 ~ Oct. 15),
- Initial meetings and interviews of key personnel and project counterpart,
- Interviews and meetings with all relevant agencies and departments,
- Obtain data, reports and other documents related to the past and present solid waste production, collection, disposal and management,
- Research and analyze policies, laws and regulations related to solid waste collection,

- Research and analyze current processes, systems, equipment, and manpower related to solid waste collection,
- Analysis of ISWMP (Integrated Solid Waste Management Program), and
- Visit Mangrove Pond Landfill.

2.3.2. Case Study and Recommendation Stage

The main purpose of the Case Study and Recommendations Stage was to research and study the Best Practices and case studies of solid waste collection in Korea. Using the results of the As-Is Analysis and the case study of Korea, improvement points and recommendations were made related to solid waste collection and management in Barbados.

The following activities were performed during this stage:

- Research and analysis of Korea's Best Practices and case studies in solid waste collection and management in Korea (policies, systems, services, included),
- Interview and have meetings with regional government offices related to solid waste collection in Korea,
- Interview and have meetings with companies that are involved in solid waste collection in Korea,
- Based on the As-Is Analysis and case study in Korea, determine improvement points and recommendations to improve the solid waste collection and management in Barbados, and
- Perform study of route optimization program in Barbados for solid waste collection.
- Determine improvement points for solid waste collection and disposal process and system based on As-Is Analysis and case studies in Korea.
- Determine additional manpower, equipment, and system requirements to implement the route optimization program.
- Perform feasibility study and economical analysis of implementing the route optimization program for solid waste collection.

2.3.3. Dissemination Seminar Stage

The main purpose of the Dissemination Seminar Stage was to present the final results of the Consulting Project to all stakeholders in Barbados.

The following activities were performed during this stage:

- Plan and preparation of the Dissemination Seminar,
- Execute the Dissemination Seminar in Barbados (Nov. 16 ~ Nov. 18) in accordance to the requirements of all stakeholders, and
- Present the final results of this Consulting Project during the Dissemination Seminar.

2.3.4. Capacity Building Workshop Stage

The main purpose of the Capacity Building Workshop Stage was to invite experts in solid waste collection from Barbados and other neighboring Caribbean countries to Barbados in order to share knowledge concerning solid waste collection and to obtain comments concerning the route optimization program proposed to Barbados. The suggestions and comments received during the Workshop were used to finalize the results of the Consulting Project. The Workshop was jointly planned and executed with IDB and the funds for the execution of the Workshop were sponsored by both KEXIM and IDB.

The following activities were performed during this stage:

- Planning and preparation of Capacity Building Workshop : activities, lectures, programs, discussion points,
- Preparation of the schedule and study materials for the Workshop,
- Execute the Workshop to the satisfaction of the invited guests on Dec. 7 ~ Dec. 11; 11 participants from neighboring countries will be sponsored by KEXIM while IDB will sponsor the meals and venue, and the participants from Barbados will be sponsored by PMCU where minimal costs will be associated with participants from Barbados.

- During the Workshop, Best Practices and case studies in Korea will be presented and shared with all participants,
- During the Workshop, representatives from other neighboring countries will share their current status and future plans in solid waste collection, and
- During the Workshop, the final results of this Consulting Project will be shared with all participants in order to receive their comments and suggestions, and
- Prepare Final Report to be delivered by Dec. 30, 2015

2.4. Consulting Team

The Consulting Team was a consortium between three organizations: namely Dongbu Inc. who was the main member with numerous international consulting experiences, Korea Waste Association who is the leading authority in Korea for solid waste collection, and GDC who is a consulting company specializing in feasibility study and economic analysis.

Table I-2 | Consortium Members



Main Member	Partner Member	Partner Member
Dongbu Inc. 	Korea Waste Association 	GDC Consulting 
Extensive experience in international consulting and KSP projects	Extensive knowledge in solid waste collection and management	Extensive experience in conducting feasibility study and economic analysis
<ul style="list-style-type: none"> • Project management • Communication with KEXIM, IDB and PMCU • Quality management 	<ul style="list-style-type: none"> • As-Is analysis and recommendations related to solid waste collection and management 	<ul style="list-style-type: none"> • As-Is analysis and economic analysis of policies and financial impact of route optimization

Table I-3 | Roles and Responsibilities of Consultants

Role	Name	Responsibilities	Experience
PM (Project Manager)	Park, SangWook	<ul style="list-style-type: none"> • Overall project management • (resource, delivery, quality) • Main contact for project 	<ul style="list-style-type: none"> • Ph.D. • 7 overseas consulting projects
Waste Technology	Min, Dal Ki	<ul style="list-style-type: none"> • As-Is analysis and development of route optimization program 	<ul style="list-style-type: none"> • Ph.D. (Environment) • 17 projects related to waste
	Kim, Hak Joo	<ul style="list-style-type: none"> • As-Is analysis and recommendations of solid waste collection 	<ul style="list-style-type: none"> • Master (Environment) • 7 projects related to waste
	Sung, Nak Kuen	<ul style="list-style-type: none"> • As-Is analysis and recommendations of solid waste collection 	<ul style="list-style-type: none"> • Bachelor (Environment) • 16 projects related to waste
	Lee, Jung Heon	<ul style="list-style-type: none"> • As-Is analysis and recommendations of solid waste management 	<ul style="list-style-type: none"> • 12 projects related to waste
Policy and Financial Analysis	Lee, Kyung Wan	<ul style="list-style-type: none"> • Feasibility Study of implementing the route optimization program 	<ul style="list-style-type: none"> • 4 overseas and feasibility study projects
	Lee, Kye Chun	<ul style="list-style-type: none"> • Financial and economical analysis of implementing the route optimization program 	<ul style="list-style-type: none"> • Masters (Financial analysis) • 12 financial analysis projects
	Lee, Seung Yong	<ul style="list-style-type: none"> • As-Is analysis and recommendations on policies related to solid waste collection and management 	<ul style="list-style-type: none"> • Bachelors (Environment) • 8 overseas projects
Project Support	Kim, Ho Chang	<ul style="list-style-type: none"> • Plan and execute Capacity Building Workshop • Research of Best Practices 	<ul style="list-style-type: none"> • 12 overseas projects (6 projects with workshops)

3. Expected Results

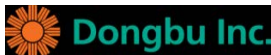
The following were the expected results of the Consulting Project:

- With Barbados as the key reference site and since Barbados is one of the leading countries in the Caribbean in terms of solid waste collection and management, improvement points and advanced systems and processes proposed in this Consulting Project could also be expanded and adapted to other neighboring countries in order to raise the overall level of solid waste collection and management throughout the Caribbean.
- The results of the Consulting Project could be used as the basis for future projects in solid waste collection, disposal and management. Barbados will be able to apply for IDB, GCF (Green Climate Fund) or other ODA (Official Direct Assistance) funds as a follow up project from the results of this Consulting Project.

[INTENTIONALLY LEFT BLANK]

II. Analysis of Current Status

1. Law and Policy in Barbados

1.1. Organization

The main organization concerning solid waste management in Barbados is the Ministry of Environment and Drainage (MED) and the MED is responsible for developing and executing the law, regulation and policies related to solid waste collection, disposal and management. Under the MED, there are three main departments who are involved in solid waste management and they are the Project Management Coordination Unit (PMCU), Sanitation Services Authority (SSA) and the Environmental Protection Department (EPD) (Please refer to Figure II-1 on the next page). PMCU is responsible for the implementation of the Integrated Solid Waste Management Programme (ISWMP) and they are the main counterpart organization for this Consulting project. SSA is a quasi-government agency responsible for the collection and disposal of solid waste. EPD is responsible for the regulation, enforcement and monitoring of the laws related to solid waste collection, disposal, and management. The Environmental Health Department (EHD) works in conjunction with the EPD; however, EHD is not part of the MED but under the Ministry of Health. The Sustainable Barbados Recycling Center (SBRC) is a PPP (Public Private Partnership) where the SSA reimburses SBRC for some of the services SBRC provide such as 1) automatic weighing of collection trucks as the trucks enter and leave SBRC, 2) acting as a transfer station where wastes are unloaded and separated prior to the delivery to the landfill, and 3) recycling of the waste that are unloaded by the collection trucks.

There are around 12 private companies involved in solid waste collection and management and the three largest are Simpson Trucking and Skip Services, Jose and Jose, and Garbage Master. There are also some companies involved in recycling paper, plastic, glass, metal, etc. and the three largest are B' Recycling, Ace Recycling and Scrap Man. Other than the recycling companies, all the private haulers also take their collected solid waste to the SBRC to be processed and residue disposed of at the landfill.

Figure II-1 | Organizational Chart of Solid Waste Management in Barbados

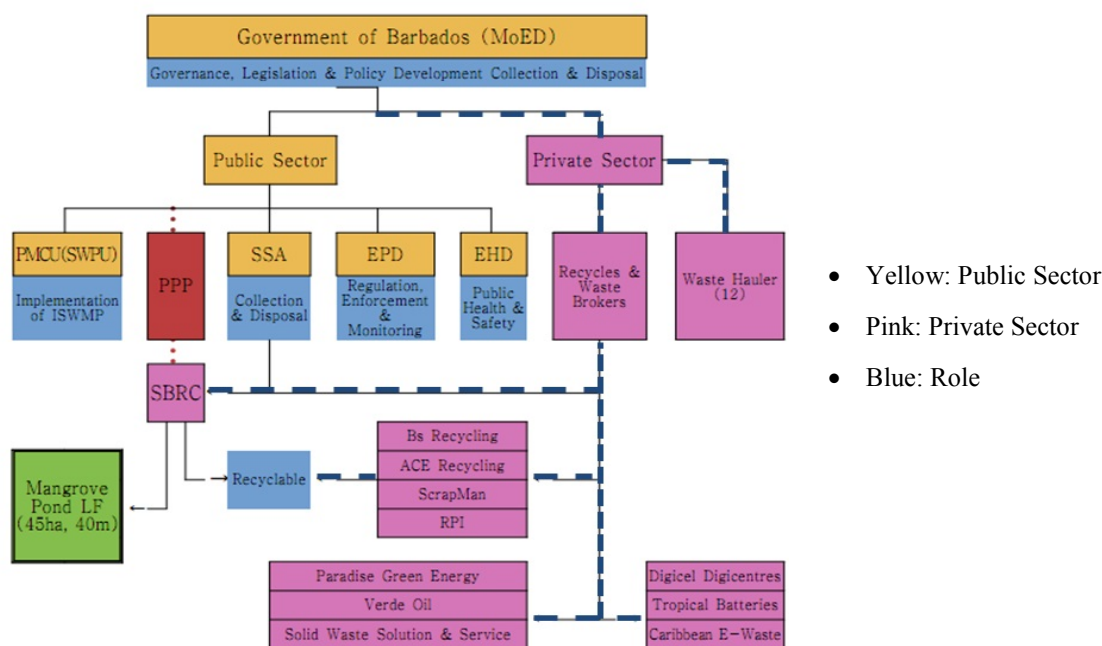

1.2. Solid Waste Related Law and Policy

The main laws related to solid waste is the “Waste Management Act”(draft version) and the “Licensing Relations” related to the execution of the law. Other related laws are the Sanitary Service Act, Health Service Act, Town and Country Planning Act, Marine Pollution Act and the Coastal Zone Management Act.

The main policy related to solid waste is the Integrated Solid Waste Management Programme (ISWMP) which was started in 1993. There were many revisions and amendments to the ISWMP since 1993 and it is also a major part of the government-wide Barbados Sustainable Development Policy (BSDP) which was launched in 2004.

Solid waste characterization studies are also performed every ten years (1994 and 2005) and Barbados is currently undergoing the latest study where the draft version of the study was received and was reviewed. In the “National Strategic Plan of Barbados 2005~2024”, Major Target 4 deals with “Strengthening the Physical Infrastructure and Preserving the Environment” where solid waste management is outlined as one of the key issues that the Government of Barbados (GOB) will be focusing on for the next 25 years.

Later, with the emergence of national waste management as an international environmental issue, Barbados established the 1993 Health Sector Development Plan and the ISWMP is currently being implemented as part of this Plan. The ISWMP focuses on various stakeholders from both the public and private sectors working together to change the existing bad practices of illegal disposal of wastes, to minimize the disposal of solid waste, to promote recycling, and to provide guidance to convert solid wastes into resources. By presenting a long term vision for solid waste management for the next 20 years, the goal of the ISWMP is to develop a modern and sustainable management system that is efficient and reliable in order to effectively manage the solid waste disposal throughout Barbados and protect the environment.

The objectives of the ISWMP can be categorized into three parts. The first objective is to reduce the disease and environmental contamination from wastes resulting from illegal disposal and existing bad disposal practices. The second objective is to improve the sanitation standards of Barbados by developing and providing an efficient and reliable solid waste management system, and the third objective is to provide programs to promote awareness and educate the public in order for the citizens of Barbados to manage the environment on their own. The participation of the private sector stakeholders in the solid waste management system, and the reduction of volume and toxicity of the solid wastes are also included in the third objective (PAHO, 2003).

The ISWMP is composed of physical elements and non-physical elements. Physical elements are the facilities such as the landfills, solid waste management depots, and large waste disposal facilities. The solid waste disposal depots should include transfer stations, materials recovery facilities, chemical waste storage facilities, and composting facilities. Additionally, improving the roads to effectively transport the wastes to the disposal facilities are also included in this element (PAHO, 2003).

The non-physical elements of the ISWMP are reinforcing the solid waste management system by establishing organizational and advisory groups, who can implement all aspects of the solid waste disposal process and can supervise the status of progression of the ISWMP. Developing policies and laws related to improving solid waste disposal, increasing public awareness and providing educational programs on the importance of solid waste management for various stakeholders such as employees of major governmental agencies, semi-governmental organizations and private waste collection companies are all considered

to be non-physical elements as well. Furthermore, looking for more economical ways to recoup the solid waste management expenses are also included in this category (PAHO, 2003).

Table II-1 | Summary of ISWMP

Category	Details
Program Name	Integrated Solid Waste Management Program (ISWMP)
Start Date	Temporary Stat Date : 1993 Actual Start Date: 1995
Execution Agency	Project Management Coordination Unit (PMCU)
Objective	<ul style="list-style-type: none"> - Development of a modern and sustainable solid waste management system that is efficient and reliable. - Vision for solid waste management for the next 20 years.
Composition	<ul style="list-style-type: none"> - Improve the landfills - Establish solid waste management depots and large waste disposal facilities - Improve the road conditions - Reinforce the solid waste management system - Develop policies and laws for solid waste management - Promote public awareness and operate educational programs on the importance of solid waste management - Find ways to economically recoup the solid waste management expenses

Source: PAHO. (2003). *Country Analytical Report Barbados*. PAHO

2. Current Status of Solid Waste Collection in Barbados

2.1. Classification of Waste

The Waste Management Act does not clearly define the classification of waste; however, generally the waste is classified as 1) Municipal Solid Waste (MSW), 2) Industrial, Commercial and Institutional (ICI) or Commercial and Institution (CI), 3) Construction and Demolition (C&D) waste, and 4) Rock and Soil (R&S). Another way to classify waste is by using the content of waste such as 1) garbage or MSW, 2) Green Waste (GW), 3) C&D and 4) R&S. The “Characterization Study 2005” classified waste as 1) Residential Refuse 2) Residential Yard Waste, 3) Commercial Refuse, 4) Commercial Yard Waste, 5) Bulky Waste, 6) Hazardous Waste, 7) Special Liquid Waste, and 8) Imported Waste. The definition of waste is currently being undertaken in the revised policy.

Since there is no classification of waste defined in the Waste Management Act, there is also no waste code (number) associated with the different waste classifications. Waste code is very important in the management of waste; therefore, the waste codes defined in the characterization studies are currently being used to manage the different types of waste. We can see a continuous increase in the number of classifications of waste (thus, the number of waste codes) from the initial characterization study performed in 1995 which had 34 classes to the latest study performed in 2015 which has 52 classes. Currently, codes 1~8 classifies paper and cardboard, codes 9~13 classifies glass, codes 14~21 metal, codes 22~28 plastic, codes 29~30 textile, codes 37~42 construction waste, codes 43~48 special care waste and codes 49~52 other waste. The different codes define the different methods of recycling and processing of the waste which is a very efficient coding system. The waste codes can also be used as keys to identify the different types of waste in a computer system.

2.2. Production of Waste

Usually the increase in waste production is linked with the increase in population and the increase in income. However, in Barbados, there is minimal increase in population; therefore, the yearly increase in waste production is linked to the increase in GDP. Before 2001, the yearly increase in waste production was only 3%; however, from 2001 to 2010, the

yearly increase rose to over 11% which is directly linked to the large increase in GDP during this period. Then after 2010, the yearly increase has fallen back to the 3% level.

The sum of MSW production and GW production was 150 tons per day in 2001, then in 2010 the amount increased to 400 tons per day and in 2014, the amount has increased to 450 tons per day. 450 tons per day translates to 1.68 kg of waste produced per person every day. The average waste production for advanced countries is about 1 kg per person per day so Barbados's waste production is much higher than the average and we can assume two main reasons for this higher amount. One is because tourism is one of Barbados' main industries and the second is due to the large amount of GW produced.

The total sum of all waste produced, including MSW, GW, C&D and R&S, is about 1,000 tons per day (300 tons per day for MSW, 150 tons per day for GW, 150 tons per day for C&D, and 400 tons per day for R&S). Table II-2 shows the amount of waste received by SBRC for the last 5 years. You can see that the total amount of waste received by the SBRC has increased continuously for the last 5 years. The waste collected by SSA accounts for about 21.7% of the total (78,703 tons out of a total 360,526 tons) and you can notice that the amount of waste collected by SSA stays rather constant between 77,000 tons to 83,000 tons per year for the last 5 years which means that the population is not increasing very much. The main increase in the total amount of waste comes from the private haulers, meaning that the increase in waste production is due to increase in tourism and businesses.

Table II-2 | Waste received by SBRC for the last 5 years (in tons)

Year	Collector		Total
	SSA	Private	
2010	50,780	157,855	208,635
2011	81,105	162,488	243,593
2012	77,195	220,214	297,209
2013	83,921	271,114	355,035
2014	78,703	281,823	360,526

2.3. Composition of Waste

Table II-3 shows the composition of MSW and ICI waste in the latest “Characterization Study 2015”. For MSW, 36% are organic waste with paper, textile and plastic accounting for 15%, 11%, and 10%, respectively. For ICI, 48% are organic waste and 35% are C&D and these two types of waste account for 83% of all ICI. Paper, plastic, textile and organic waste account for 92% of the overall waste production by households and the remaining 8% are glass and metal waste.

Table II-3 | Composition of Waste (2015)

Category	MSW	ICI	Combined	
Paper	14.9 %	3.6 %	10.28 %	92 %
Plastic	9.5 %	5.0 %	7.70 %	
Textiles	10.9 %	1.7 %	7.16 %	
Organics	36.4 %	47.7 %	41.00 %	
Glass	3.0 %	1.5 %	2.40 %	8 %
Metal	3.9 %	1.9 %	3.07 %	
C&D	9.8 %	35.0 %	20.09 %	
special care waste	0.2 %	0.2 %	0.20 %	
other waste	11.4 %	3.4 %	8.10 %	
Total (%)	100 %	100 %	100 %	

2.4. Waste Management

The general waste management process is as follows:

Generation → Storage (on-site) → Collection → Transportation → Processing

Usually, task of collection and the task of transportation are separated and executed by different companies or organizations. In this case, collection can be performed using large

non-compactor trucks and the waste delivered to transfer stations where the waste is separated and compacted for delivery. However, in Barbados, due to the small size of the country, both collection and transportation are carried out by the same company or organization using compactor trucks. Also, there are no in-between transfer stations handling the waste separation prior to delivery to the SBRC. SBRC can be considered the only transfer station prior to the delivery to the landfill.

In Barbados there are no requirements for separation of recyclable waste versus non-recyclable waste. The only separation of waste done at the households are the separation of containers made of glass, polyethylene terephthalate (PET), or metal since these containers can be brought to recycling centers for exchange of money (based on the Returnable Containers Act). These recyclable wastes account for about 20% of the total waste generated at the households (about 60 tons per day).

The generated wastes are placed in plastic bags (designated trash bags or regular plastic bags provided at the markets) and placed at the curb for pick-up. The plastic bags can just be piled on the curb or placed in individual trash bins which can be purchased. The 60 to 100 liter trash bins are made of plastic with holes drilled at the bottom to remove liquid, which are generated by the waste. The trash bins make the waste collection easier for the loaders. Other than households, skips can be used to store plastic bags or other trash generated by commercial businesses or apartments. The Figure below shows the storage on-site of the generated waste in Barbados.

Figure II-2 | Waste Storage On-Site



(a) Bag and Bin



(b) Skip Container

2.5. Waste Collection

The SSA divides Barbados into 5 major regions for waste collection. The regions are City West, City East, South West, South East and North (shown in Figure II-2 below). Bridgetown, where 42% of the total amount of waste is generated is divided into two separate regions, City West and City East. In Barbados, there are 3 major depots where collection trucks are parked and distributed from. The Wildey Depot is the main depot with about 40 trucks (operational or not). There is a depot in Bridgetown at Reed Street with 1 compactor truck and 1 skip truck. Finally, there is a small depot in the North at Greenland with 3 trucks.

Table II-4 shows the amount of waste collected by region in 2014. There were only 4 regions in 2014 where the South was divided into two regions this year.

Figure II-3 | Regions for Waste Collection



Depot	Driver	Loader
South East	10	20
South West	11	22
North	11	22
City West	16	32
City East	11	22
Commercials	6	12
Total	65	130

[INTENTIONALLY LEFT BLANK]

Table II-4 | Waste Collection by Region (2014)

Category	Region				Total
	City West	City East	South	North	
No. of trip	2,822	3,950	4,014	3,523	14,309
Tons received	14,565	15,601	23,213	18,267	71,646
Ton/trip (average)	5.16	3.95	5.78	5.19	5.00

The residents bring out their waste to the curb and place the plastic bags on the curb or put the plastic bags into 60 to 100 liter trash bins. Barbados is currently using a house-to-house, “alley service” method of collection. In larger apartments or buildings, skip container based “block service” method of collection is being used. In the city, street cleaners roll along large garbage cans to place sweep the streets as well as collect garbage from trash bins or directly from the streets. Figure II-4 shows the type of collection equipment used by SSA.

Figure II-4 | Waste Collection Equipment



(a) Street Cleaning



(b) Lorry Loader



(c) Compactor Truck



(d) Open Truck



(e) Skipped Truck

Comparing waste management status of Barbados with the current waste management status of Seoul, Korea, the land area of Barbados is about 71% of the land area of Seoul; however, Barbados only has 2.6% of Seoul’s population, 5.3% of Seoul’s waste generation, 5.0% of persons associated with waste collection and 3.5% of the number of waste collection equipment (please refer to Table II-5 below).

Table II-5 | Comparison of Barbados and Seoul

Category		Barbados	Korea	Seoul	
Land area (square meter)		430	100,368	605	
Population (1,000 person)		268	51,710	10,143	
Province/District		11 province	8 M-city & 8 province	25 district	
Waste generation (tons/day)		450	48,728	8,559	
Collection & Transportation	Public Sector	Manpower	300	34,014	6,018
		trucks	64	11,446	1,868
	Private Sector (Number of companies)		12	4,035	143
Public Facility	Incinerator	0	182	5	
	Landfill	1	221	1	
Budget (USD per year)		28M (overall)	4,110M	679M	

2.6. Waste Processing

The waste processing in Barbados has a very simple structure. Recyclable goods collected at the private recycling companies and the SBRC are mostly exported to China or to South America. Most of the MSW generated are buried in the Mangrove Pond Landfill without incineration.

Figure II-4 shows the waste collection, disposal and management process in Barbados depending on the classification of waste. About 1,000 tons of waste are collected and

delivered to the SBRC every day (MSW 300 tons/day, GW 150 tons/day, C&D 150 tons/day, and R&S 400 tons/day). SSA is responsible for collecting about 180 tons of waste per day and the remaining 800+ tons of waste are being collected by private companies. Most of the 1,000 tons of waste collected per day either go to the landfill to be buried (400 tons/day) or is being used for land reclamation (540 tons/day). The remaining 60 tons of waste are being recycled; therefore, about 6% of the total amount of waste is being recycled which is very low compared to Korea where about 60% of the waste is being recycled. Recycling is important because it diverts a large amount of waste going to the landfill.

Figure II-5 Waste Processing in Barbados

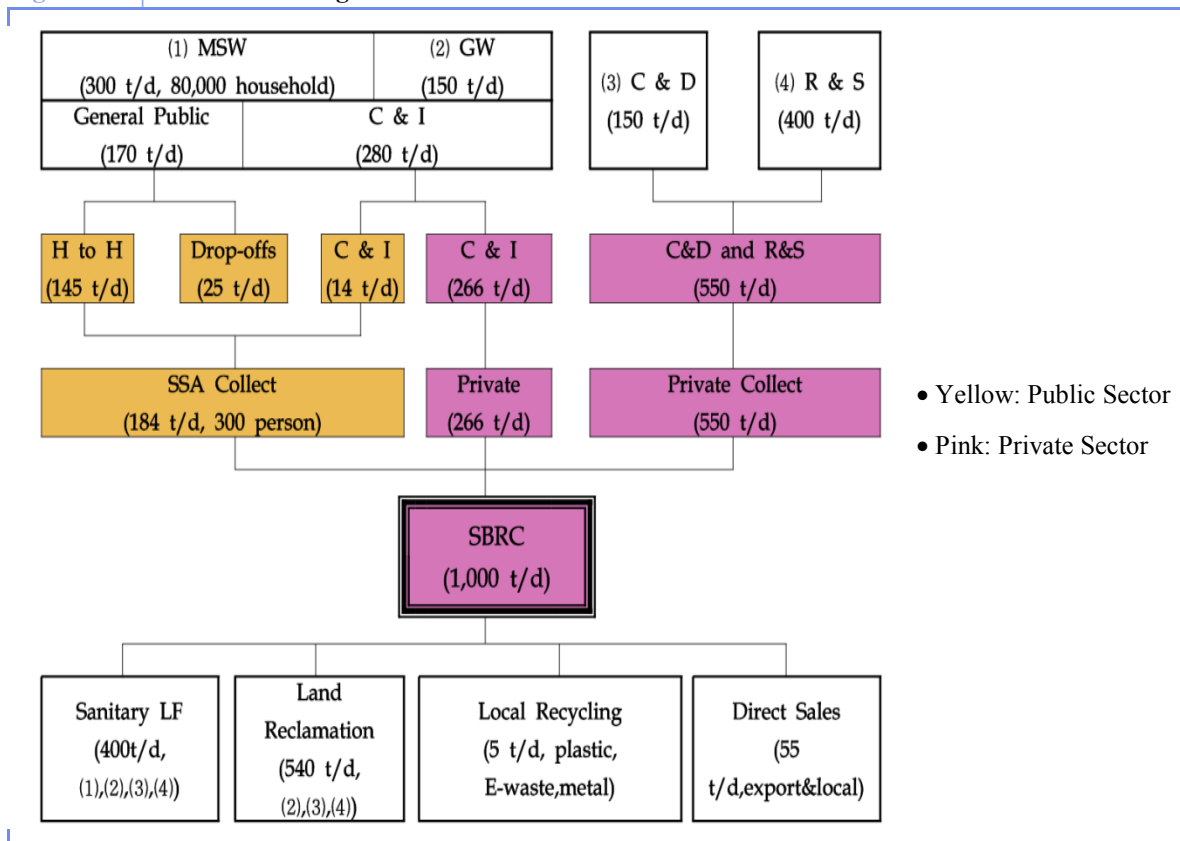

[INTENTIONALLY LEFT BLANK]

3. Problems and Issues

The two biggest problems and issues in waste collection in Barbados are 1) collection trucks and 2) roads. In case of collection trucks, the biggest problem is that the trucks and facilities are old and outdated. There should have been a continuous purchasing of at least a small number of trucks every year or every two years; however, in Barbados, large number of trucks were purchased in 1999, 2005 and 2013 without replenishing fleet in other years. Since the trucks are old and overworked, there are constant mechanical failures mainly in the gear, brake, compactor and transmission. Since 1991, a total of 88 trucks were purchased; however, currently there are only 41 trucks that can be used and out of these 41, only 15 trucks were operational during our mission trip. The remaining trucks were in the shop waiting for replacements and minor repairs. Some trucks were completely unusable and some were outside the shop being worked on for major repairs by outsourced private companies. The percentage of operating trucks was far below 50% while in Korea, the percentage of operating trucks was maintained to levels above 85% at all times. Table II-6 shows the defect ratio of equipment.

Table II-6 | Defect Ratio of Equipment

Year of Make of Equipment	Operating	Repair		Total
		Minor	Major	
1991		1		1
1992			1	1
1994			1	1
1996			1	1
1998			1	1
1999	6	3	2	11
2000			1	1
2001			1	1
2002			1	1
2003			2	2
2005	15	5	11	31

Year of Make of Equipment	Operating	Repair		Total
		Minor	Major	
2006	3			3
2007	3	2	2	7
2008	3	1		4
2009			2	2
2010	2	1	3	6
2013	9	2	3	14
TOTAL	41	15	32	88

The other major problem is in the road infrastructure of Barbados where a lot of the roads are narrow and hard to access by waste collection trucks. There are a lot of roads with dead-ends and no turn-around points; thereby, forcing waste collection trucks to back into the dead-end roads for pickup or make hard almost impossible turns to drive out of roads. Low hanging trees or electric wires also pose problems to drivers and parked cars sometimes make it impossible to reach houses in streets with narrow roads. Other problems that arise are that sometimes persons dump their waste into other person's garbage lots or skips in order to avoid payment for excessive discharge. Table II-7 shows the troublesome issues related to waste collection.

Table II-7 | Troublesome Issues related to Waste Collection

Structural Aspects	Non-structural Aspects
<ul style="list-style-type: none"> • Low electric wire • Road trouble • Narrow road • Dead-end alley (cul-de-sac) • Road constructing • Obstacles(floating wood) in storm 	<ul style="list-style-type: none"> • Difficulty to the block collection service • Road trouble • Heavy traffic jam • Illegal car parking • Incorrect usage of free dischargers to the bins of paid dischargers

III. Case Study on Korea's Experiences

1. Korean Waste Management Laws and Policies

1.1. Development of the Waste Regulations

The Waste Management Policy of Korea which started with the 'Garbage Cleaning Law' of the 1960s has developed continuously through the establishment and amendment of the related laws and regulations. There was a dual waste management policy before 1986 because residential waste was managed under the 'Garbage Cleaning Law' while industrial waste was managed under the 'Environmental Protection Law'.

It is difficult to say that both the 'Garbage Cleaning Law' and the 'Environmental Protection Law' can be considered real waste management policies, as they only pertained to the cleaning and disposing of the wastes instead of managing them effectively and systematically.

However, with the establishment of the 'Waste Management Law' in the late 1980s, waste management became a single policy, and various waste management policies and regulations were established and implemented afterwards.

1) Establishment of the 'Garbage Cleaning Law' (1961~1986)

Established in December 1961 and abolished in December 1986, the 'Garbage Cleaning Law' focused mainly on thoroughly collecting and disposing of household garbage and human excrements in the cities. This was closely related to the social situation at the time where the neglected garbage and excrements damaged the views of the residential environments and public spaces, and the odors became a serious problem. Meanwhile, the 'Garbage Cleaning Law' was amended in 1973 to include not only household garbage and human excrements but other wastes as well.

2) Establishment of the ‘Environmental Protection Law’ (1978~1986)

As the result of the increasing awareness for environmental contamination problems as the result of the increase in industrial wastes from industrialization, the ‘Environmental Protection Law’ was established in December 1977 and enforced in January 1978. With the implementation of this law, the waste management policy in Korea became a dual policy where residential wastes such as garbage and human excrements were managed under the existing ‘Garbage Cleaning Law’, while the industrial wastes were managed under the new ‘Environmental Protection Law’.

Meanwhile, with the birth of the Korea Environmental Office in 1980 after the establishment of the ‘Environmental Protection Law’, Korea’s environmental policies became more assertive. In other words, if the existing policies were considered more passive by focusing mainly on disposing (cleaning) the wastes that were produced by households and industries, the policies after the establishment of the Environmental Protection Law became more assertive, seeking for directions to maintain a clean environment.

Furthermore, in order to reflect the social situation of increasing importance for environmental problems, the Environmental Protection Law included more assertive solutions such as the evaluation on the pollutants’ effect on environment, the environmental standards and contaminant levels for pollutants instead of preventing and improving the environmental pollutions.

3) The ‘Waste Management Law’ Era (1986~1992)

‘Waste Management Law’ was established in December 1986 to address the problems that were caused due to continuous increase of waste generation and the rising public awareness for the safe treatment and proper management of waste in Korea. Korea’s waste management policy really developed with the establishment of the “Waste Management Law”. Under the new ‘Waste Management Law’, the dual policy of ‘Garbage Cleaning Law’ (residential waste) and ‘Environmental Protection Law’ (industrial waste) became a single policy, and the concept of ‘waste recycling’ was included to accommodate the awareness in and the interest to practice recycling.

Then in 1991, a newly amended ‘Waste Management Law’ was publically announced to include such policies as waste reduction and recycling, waste collection and disposal deposits, follow-up management of the waste disposal facilities. This was closely related to the need at that time for a policy that went beyond the simple waste disposal/cleaning concept to systematically and efficiently managing the waste from the production, collection, transportation, incineration, landfill and recycling stages (Hyung-Gi Ahn, 2010).

4) Law Separation Era (1993~present)

Since 1993 until now, the unified Waste Management Law was segmented and revitalized into recycling and resource recirculation as well as actively promoting the installation of waste disposal facilities by incorporating a variety of laws and regulations. In this regard, the ‘Resource Saving and Recycling Law’ was established in 1992 and enforced from 1993. This law separated waste reduction and recycling from the existing ‘Waste Management Law’ in order to promote recycling. Accordingly, the recycling policies and regulations such as reduction of packing materials, regulations on disposable products, waste disposal deposits and fees, and encouragement of recycling industries were enforced.

Additionally, the ‘International Waste Transport and Disposal Law’ was established in 1992 and enforced from 1994 to fulfill the Basel Treaty. Accordingly, the ‘Waste Disposal Facility Installation and Local Support Law’ was separated from the ‘Waste Management Law’ in 1995. The purpose of this law is to prevent the NIMBY (Not In My Backyard) situation towards waste facilities such as incinerators by the local residents by giving them support to solve and mediate any social complications that may arise.

Laws for specific wastes were established in 2003 and 2007. These included the ‘Construction Waste Recycling Law’ of 2003 and the ‘Electric Appliances, Electronic Products, and Automobile Resources Recirculation Law’ of 2007. In particular, the ‘Electric and Electronic Products, and Automobiles Resource Recirculation Law’ was introduced for the resource recirculation concept and the product resource recirculation evaluation.

Meanwhile, the ‘Standardized Garbage Bag System’ and the ‘Forbidding of Food Garbage Accumulation and Landfill Ban’ were enforced in 1995 and 2005 respectively to reduce waste, promote separate collection through recycling, and recover resources.

1.2. Main Waste Laws

The main waste laws of Korea began with the ‘Waste Management Law’ in 1986 and developed through the ‘Resource Saving and Recycling Law’ and the ‘International Waste Transport and Disposal Law’ in 1994, the ‘Waste Disposal Facility Installation and Local Support Law’ in 1995, and then the ‘Electric Appliances, Electronic Products, and Automobile Resources Recirculation Law’ in 2007.

Table III-1 | Main Waste Laws

Year of Establishment	Name of Law	Details
1986	<ul style="list-style-type: none"> Waste Controls Act 	<ul style="list-style-type: none"> Suppress waste production Usage of eco-friendly disposable methods
1992	<ul style="list-style-type: none"> Act on the Promotion of Saving and Recycling of Resources 	<ul style="list-style-type: none"> Suppress waste production and promote recycling Promote recirculation of resources
1994	<ul style="list-style-type: none"> Act on the Control of Cross Border Transportation of Hazardous Waste and Their Disposal 	<ul style="list-style-type: none"> Regulate the importing, exporting and transiting of wastes to fulfill the ‘Basel Treaty on the Restriction of International Transport and Disposal of Hazardous Wastes’ Prevent environmental contamination from international transportation of wastes and promote international cooperation
1995	<ul style="list-style-type: none"> Act on the Promotion of the Installation of Waste Disposal Facilities and Assistance in Adjacent Areas 	<ul style="list-style-type: none"> Secure land for waste disposal facilities and support local residents Build waste disposal facilities without problems and improve the welfare of the residents
2007	<ul style="list-style-type: none"> Act on the Resource` Circulation of Electrical and Electronic Equipment and Vehicle 	<ul style="list-style-type: none"> Promote the recycling of electric appliances, electronic products and automobiles by suppressing the use of hazardous wastes, making for easy re-usage, and appropriate recycling Construct a resource recirculation system for efficient resource usage

Source: Anh. (2010). *Improvement Direction of the Waste Management Policy – Construction of an Inter-Governmental Cooperative Governance System*. Korea Local Government Society Bulletin”, Vol. 22, No. 4

With the amendment of the 'Waste Management Law' in 1995, waste was divided into residential waste and commercial waste. The 'Waste Management Law' was amended in 2007 to introduce the ‘Electronic Transfer and Takeover System’, and made it obligatory to

report the details of the wastes in order to strengthen and simplify the management process, and make it transparent. Accordingly, each time a business produces, collects, transports, recycles or disposes of wastes, all data relating to the transfer and takeover of the process has to be inputted in the electronic information processing program. Furthermore, if a business exports or imports wastes, information such as type, quantity, and disposal plans have to be reported to the Minister of Environment. Therefore, if one type of waste is imported or exported, the type, quantity, and disposal plans of the concerned waste must be reported to the Minister of Environment.

The 'Waste Management Law' was amended again recently and publically announced in July 2015, to be enforced in July 2016. The main purpose of the amendment was to manage the waste systematically and activate the recycling to develop the concerned industries and technologies. The main amendment of the 'Waste Management Law' is the systematic management of the wastes depending on the source, composition, and toxicity, while promoting the development of the new waste recycling technologies.

In order for a smooth enforcement of this amended law, the Ministry of Environment established guidelines for a more detailed waste classification, advanced and improved recycle management structure, and recycling environment evaluation, and plans to do maintenance on the enforcement ordinances and regulations.

1.3. Waste Management Plan

1.3.1. Comprehensive National Waste Management Plan

In 1993, the Ministry of Environment established the 'Comprehensive National Waste Management Plan (1993~1995)'. As the result of this plan, the 'Resource Saving and Recycling Law' was enforced (1993), the 'Waste Disposal Facility Installation and Local Support Law' was established (1995), and the 'Standardized Garbage Bag System' was implemented (1995).

However, this plan was amended due to the numerous internal and external changes which had an effect on the waste management conditions and policies. Two reasons for

this are the ‘Standardized Garbage Bag System’ and the global environmental change. First of all, for one year after the initial implementation of the ‘Standardized Garbage Bag System’ in January 1995, residential waste was reduced by 27% and recycling increased by 35%, bringing about the need for a waste management plan to respond to this. Furthermore, there was also the need for change in the central government’s policies towards the local governments who were closing themselves off after the election of the local government heads.

Globally, there was reorganization in the world order of gradual integration of environment and economy with the World Trade Organization (WTO) at the center, and Korea saw increasing need to change its environment. Additionally, as the result of the 1972 London Treaty on the prevention of ocean pollution from disposal of wastes and other matters, Korea had increasing need for new measures in preparation for the ocean disposed waste ban in the near future.

Therefore, the Ministry of Environment amended the ‘Comprehensive National Waste Plan’ which was established under the policy goal of ‘building an infrastructure for the resource recirculation economy’ as the basic plan on waste management, and established the ‘1st Comprehensive National Waste Management Plan (1996~2001)’. Then the ‘2nd Comprehensive National Waste Management Plan (2002~2011)’ was confirmed in March 2003 to fixate the policy goal of a resource recirculation waste management system where the first plan was developed further to reduce the total quantity of the wastes, recover resources and recycle as much as possible, and dispose of inevitable wastes in an eco-friendly, safe and hygienic way. ‘The 3rd Comprehensive National Waste Management Plan’ is currently being finalized.

The policy goal of the 1st Plan was ‘establishing a sustainable resource recirculation economy infrastructure’ and three main focus areas were selected to achieve the goal of promoting resource recovery to protect nature and providing the citizens with a more pleasant living environment. The three focus areas are:

- Waste Minimization. Efforts would be made to develop policies in stages to minimize the production, distribution and consumption of the wastes during the entire life cycle of a product.
- Resource Recovery. An integrated recycling system would be constructed to

promote resource recovery and increase the efficiency of the waste resource distribution.

- **Safe Waste Management.** A plan is needed to find ways to prevent environmental pollution and effectively manage harmful wastes.

Additionally, the 1st plan presented five main strategies for clarifying the roles and responsibilities of each economic group, integration and efficiency of the waste management system, minimization of wastes at each stage of a product's life cycle, promotion of regional competitiveness based on the characteristics of that region, encouragement for more public participation and establishment of a 'Green Spending' culture.

With the goal of achieving a sustainable resource recovery society or a Zero Waste Society, the '2nd Comprehensive National Waste Management Plan (2002~2011, amended in 2007)' presented six strategies. "Zero Waste" or "Zero Discharge Waste" defined as a state where zero waste is incinerated or buried but 100% of the waste is either re-used or recycled. It is an ideal or theoretical state only and almost impossible to achieve in reality. The six strategies are waste risk management, waste resource recovery, waste reduction, waste disposal facility installation and advanced management, waste management internationalization and cultivation of the recycling industry, and the construction of a customer-oriented waste management system.

The '3rd Comprehensive National Waste Management Plan (2012~2021)' is currently being finalized to include the construction of a competitive system by regions, technology development to promote waste recycling, and conduction of a national statistical study on wastes.

1.3.2. Basic Resource Circulation Plan

The In 2011, the Ministry of Environment established the '1st Basic Resource Recirculation Plan (2011~2015)' to build an upcycling basis for waste resources in accordance with the 'Resource Saving and Recycling Law' with the objective of realizing the 'Low Carbon Resource Recirculation Society'. 'Upcycling' is changing the wastes into a new material or product that is higher in value qualitatively or environmentally (Ministry of Environment, 2015). Accordingly, all wastes are considered upcycle-able

resources, that is to say, they can be recirculated 100%, and such acknowledgement is the basic precondition for the realization of the low carbon recirculation society (Ministry of Environment, 2015).

This plan which contains five strategies, was established together with the various Korean ministries such as the Ministry of Public Administration and Security, Ministry for Food, Agriculture, Forestry and Fisheries, Ministry of Knowledge Economy, and the Ministry of Land, and Transport and Maritime Affairs. The five strategies are changing to a resource recirculation society structure, realizing an improved value resource recirculation (4Rs: reduce, reuse, recycle, recover energy), building an integrated waste disposal infrastructure, cultivating the resource recirculation industry and technology development, and providing the basis for implementation such as a national resource recirculation evaluation.

Meanwhile, this plan serves as the guideline for promoting government-wide resource recirculation to present the concerned governmental ministries with mid and long term goals and strategies for waste resource upcycling and green growth.

1.4. Waste Management System

1.4.1. Extended Producer Responsibility (EPR)

The main ‘Extended Producer Responsibility (EPR)’ was enforced in January 2003 in accordance with the amended ‘Resource Saving and Recycling Law’. The goal of EPR is to strengthen the responsibilities of the waste producers to reduce wastes and promote recycling by inducing eco-friendly ways in all stages of waste management from product design, manufacturing, distribution, consumption, to disposal.

In accordance with this system, the producers have to fulfill their responsibilities depending on the number of product deliveries they receive and the obligatory quantity by products annually announced by the government. Those producers who do not fulfill their obligations are charged the ‘recycle tax’ which is less than 1.3 times the cost to collect and recycle a product. The producers are also required to pay an allotted fee to the Recycle Business Co-operative.

Table III-2 | Products Included in EPR

Classification	Items
Products	<ul style="list-style-type: none"> - Home appliances (TVs, refrigerators, washing machines, mobile phones) - Batteries (mercury, silver-oxide, nickel, cadmium) - Tires, lubricants, florescent lights
Packaging	<ul style="list-style-type: none"> - Paper packs, glass bottles, metal cans, and synthetic resin material used for holding or packaging food and drinks, agricultural products, fishery products, meat products, detergents, cosmetics, pharmaceuticals, and butane gases

Source: KMOE, KERC. (2005). *Extended Producer Responsibility*. KMOE, KERC

Meanwhile, the fulfilling of the obligatory recycling amount can be executed in either of three methods. The first method is for the producer to recycle them himself, and the second method is for the producer to hire a recycling company for the job. The third method is for the producer to join the Recycling Business Co-operative and pay the allotted fee. If a producer chooses to fulfill the recycling obligation using either the first or the second method, then there is an incentive given to the producer where a deduction is provided for the amount of payment of the allotted fee. The amount of deduction is proportional to the recycling amount multiplied by a deduction factor determined by the Ministry of Environment.

1.4.2. Standard Garbage Bag System

The ‘Standard Garbage Bag System’ was enforced in January 1995. The targets for this system are household garbage and wastes from small businesses that have the similar composition to the recyclable residential wastes.

This is a system where the waste producer pays a fee for the wastes they throw out, thus reducing waste and increasing recycling. The fee is collected through the sale of special garbage bags or stickers designated by each local government for the wastes. Accordingly, the levying of the garbage fee changed from a fixed amount based on property tax or building area, to be proportional to the waste output (through usage of the ‘standard garbage bags’).

According to this system, waste has to be disposed of at a specific area using the standardized garbage bags but if these special bags are not used and the offender is identified, a fine of less than 1 million won (U\$850) is charged. However, the standardized garbage bags are not required and collected free of charge for recyclable wastes if they are disposed of in accordance with the guidelines of the local governments. For those large wastes that cannot be disposed of in the standardized garbage bags, households need to call the local district office and ask for removal of the waste with some payment. The payment amount and an invoice is issued by the local district office and the households need to go to any bank to make the payment (invoice is needed for payment).

1.4.3. Sharing Expenses System

The ‘Sharing Expense System’ was introduced in 1993 to suppress the production of wastes from the product manufacturing stages as well as to prevent waste. This system charges a waste disposal fee to the manufacturer or importer of products, supplies or containers that contain harmful materials or are difficult to recycle, causing problems in waste management. These products include containers for insecticides and hazardous products, antifreeze, gum, disposable diapers, cigarettes, and plastics.

The “sharing expense fee” is included in the special accounts for environmental improvement and used for the promotion and activation of recycling. The purpose of the fee is to purchase and store recyclable resources, support recycling businesses and install waste disposal facilities, research and develop technologies to effectively recycle and reduce wastes, and support the local governments in the collection and recycling costs of the wastes.

1.5. Summary and Implications

In reviewing the development trends of Korea’s waste management policies based on the contents discussed, it is apparent that as time went on, development took place in Korea in the order of ‘garbage cleaning - waste reduction - safe handling of wastes and waste management reinforcement - recycling and resource recirculation’. In other words, from cleaning or reducing wastes, the policies gradually progressed and developed into efficiently

and effectively managing and using recyclable wastes, to improving the usage value or adding new value to the wastes as if the wastes were also resources as well.

In the past before the industrialization era, when Korea's main concern was 'how not to go hungry' and livelihood was the most important thing for the people, residential wastes were almost neglected. However, with the continuous increase in population and livelihood activities became more vigorous, the wastes produced also grew drastically and the previously neglected wastes not only damaged the views of the residential environments but also public spaces such as roads as well, while the serious odors became an important social issue. Hence, the 'Garbage Cleaning Law' was established in 1961 to dispose the wastes to provide a pleasant living environment, becoming the starting point for waste disposal.

However, with the increase of industrial wastes resulting from industrialization which was taking place in the late 1970s, industrial wastes became a separate category under the 'Environmental Protection Law' of 1977. In addition, with the increasing wastes resulting from industrialization leading to environmental pollution problems, and the rise in awareness of the importance in environmental protection, political weight began to move from just cleaning up the garbage to slowly reducing the amount of waste to fundamentally and actively solving the waste issues and seeking ways to protect the environment.

Through the establishment of the 'Waste Management Law' in the late 1980s, the waste management policy entered a full-scale progressive stage. With the importance of safe treatment and reinforcement of waste management becoming more apparent as the result of the continuously increasing wastes, policies for residential wastes and industrial wastes integrated as one comprehensive structure. Furthermore, a new concept of 'recycling' was introduced in the 'Waste Management Law' by changing the thinking of wastes as simply being 'useless garbage that need to be removed' to 'materials that can be used again'. This thought process became the starting point for drawing up a policy to systematically and efficiently manage all the stages of waste management from waste production, collection, transportation, incineration, landfill and recycling.

Figure III-1 | Development Trends of Korea's Waste Management Policies

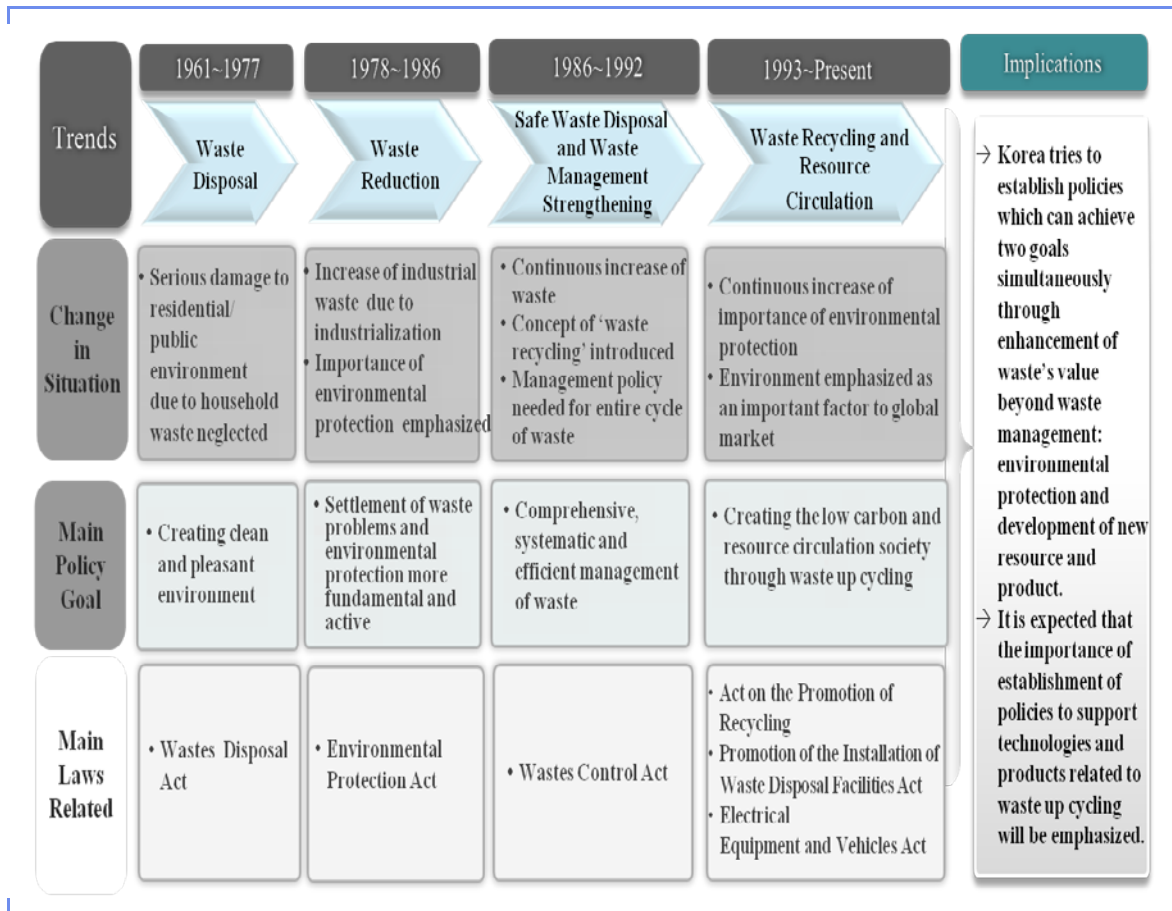

Meanwhile, the waste management policy from the 1990s until the present has focused on increasing not only recycling based on the ‘Resource Saving and Recycling Law’, the ‘Electric Appliances, Electronic Products, and Automobile Resources Recirculation Law’, and the ‘Standardized Garbage Bag System’, but also on building a ‘Low Carbon Resource Recirculation Society’ through ‘Waste Upcycling’. It can be said that the increasing awareness on the importance of environmental protection within Korea had a large impact on such trend, but the global trend of focusing on national competitiveness and world order as well as ‘environment’ and ‘economy’ centering around the World Trade Organization (WTO) also had a considerable affect.

‘Waste Upcycling’ is one step further in development beyond ‘waste recycling’. In other words, it is adding a new design or process to a waste to add value qualitatively and environmentally and recreating a new material or product. When waste upcycling actively takes place, not only will waste reduction and recycling be achieved, but also will secure the necessary resources to manufacture a new product effectively from the point of view of costs

and productivity. Furthermore, new industries can be created and developed centering on waste upcycling.

In order for these effects to be actually displayed, there is a need for a policy to back up the waste upcycling. Accordingly, it will be interesting to see the outcomes of the ‘1st Basic Resource Recirculation Plan (2011~2015)’ established by the Korean government in 2011 by emphasizing the importance of waste resource upcycling and the follow up policies developed afterwards. Also, during the follow up policy establishment processes, it will be important to seriously consider the efficient management of the wastes as well as the upcycling technologies and policies supporting product development, bearing in mind the upcycling process itself.

1.6. Comparison of the Waste Management Policy for Barbados and Korea

The waste management policy of Korea started with the ‘Garbage Cleaning Law’ in 1961 to clean up the garbage of the cities, and influenced by industrialization, the ‘Environmental Protection Law’ was enforced in 1978 to manage the industrial wastes, looking for ways to actively improve the environmental pollution. Additionally, with the enforcement of the ‘Waste Management Law’ in 1986 to efficiently manage the increasing wastes, the ‘Garbage Cleaning Law’ and the ‘Environmental Protection Law’ were integrated into one.

‘The Health Services Act (law to promote and preserve health)’ of Barbados started to manage the wastes in 1969, and with the gradual increase in population and development of the tourism industry, the ‘Integrated Solid Waste Management Programme (ISWMP)’ was enforced in 1993 to improve Barbados’s weak area of solid wastes.

Both Korea and Barbados integrated the relevant waste policies in 1986 and 1993 respectively in order to efficiently manage the wastes, but Korea opens the ‘Law Separation Era’ in 1993 by establishing separate laws for each waste product. That is to say, the focus of Korea’s waste management policy is in suppressing the production of wastes and promoting resource recirculation through recycling, and thus various waste systems that were previously regulated by the traditional Waste Management Law were separated into the Resource Recycling Law and the Individual Recycling Law (Chae, 2009).

Korea currently not only has policies to increase waste recycling, but also established the ‘1st Basic Resource Recirculation Plan (2011~2015)’ to realize the ‘Low Carbon Resource Recirculation Society’. In order to achieve the low carbon resource recirculation society, the policy makers in Korea are aware that all wastes are resources that can be upcycled 100%. Barbados also has established the ‘Barbados Sustainable Development Policy (BSDP)’ and ‘The National Strategic Plan of Barbados 2005~2015)’ to establish the basic principles for sustainable development.

Both Korea and Barbados have developed policies and legal structures for solid waste management differently in accordance with the social, cultural, economic, and geographical environments of each country. If Korea strengthens the legal system of the necessary areas through segmentation of Korea’s relatively multi-complex industrial structure, various international stakeholders and rapid growth, Barbados has a relatively simple industrial structure to manage the solid wastes integrally. However, both countries are striving for a resource recycling and resource recirculation society for sustainable development.

2. General Status of Waste in Korea

2.1. Definition and Classification of Waste

In Under Article 2 of the “Waste Management Law”, waste is defined as ‘materials that are no longer needed in people’s lives or business activities’. Also, residential wastes are wastes other than the business wastes, while business wastes are wastes produced by air, water quality, noise and vibration discharging facilities and businesses designated by the presidential decree. Designated wastes are those such as waste oil and waste acid that can pollute the surrounding environments or those that can be harmful to the body such as medical wastes and determined by the presidential decree.

Figure III-2 | Classification Structure

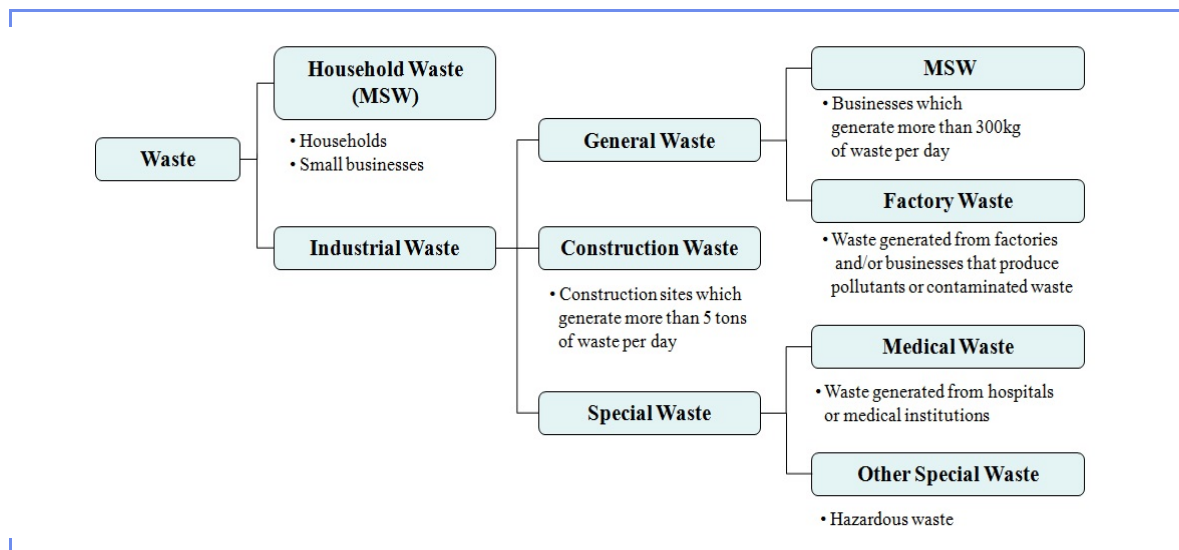

The classification of the wastes can be categorized largely into residential wastes and workplace wastes, where residential wastes are those other than the workplace wastes, and workplace wastes can be classified into three types – general workplace wastes, construction wastes, and designated wastes. Here, general workplace wastes are classified as workplace wastes and discharging facilities wastes, and designated wastes are classified as medical wastes and designated wastes other than the medical wastes. In other words, workplace wastes are those that are discharged more than 300kg per day or more than 5 tons as the result of a series of constructions or work (excluding construction companies), and discharging facilities wastes are wastes produced by air, water quality, noise and vibration discharging facilities, end waste water treatment facilities, public sewage treatment facilities, human excretion treatment facilities, public animal excrement treatment facilities, and waste disposal facilities. Construction wastes are wastes from construction companies producing more than 5 tons from construction work.

2.2. Waste Generation and Disposal

2.2.1. Waste Generation

Under the “Waste Controls Act” the Korean government conducts research every year to determine the source of the produced wastes, types and principal treatment agents, treatment methods, and treatment status, and a national statistical waste

research every five years to use as the basic data for policy establishment.

Waste quantities from 1999 until 2012 continued to increase starting in 1999 from 219,217 tons/day, and increasing close to twice the amount in 2012 at 394,510 tons/day. Looking at the compositions, there was no big change in the residential wastes and designated wastes, but the composition of the general workplace wastes increased by about 1.4 times, while construction wastes increased by approximately 3 times. When looking at the waste status ratio in 2013, construction waste was approximately 47%, general workplace wastes was 37%, residential wastes was 12%, and designated waste was about 3%.

Figure III-3 | Waste Generation for the last 15 years



Source: KMOE. (2015). *2014 Environmental White Paper*. KMOE

In looking at the composition of the residential wastes based on the 2013 results, combustibles was largest with 18,420 tons/day (38%), recyclables was 13,935 tons/day (28%), food was 12,501 tons/day (26%), and incombustibles was 3,872 tons/day (8%).

Figure III-4 | Composition of Residential Waste

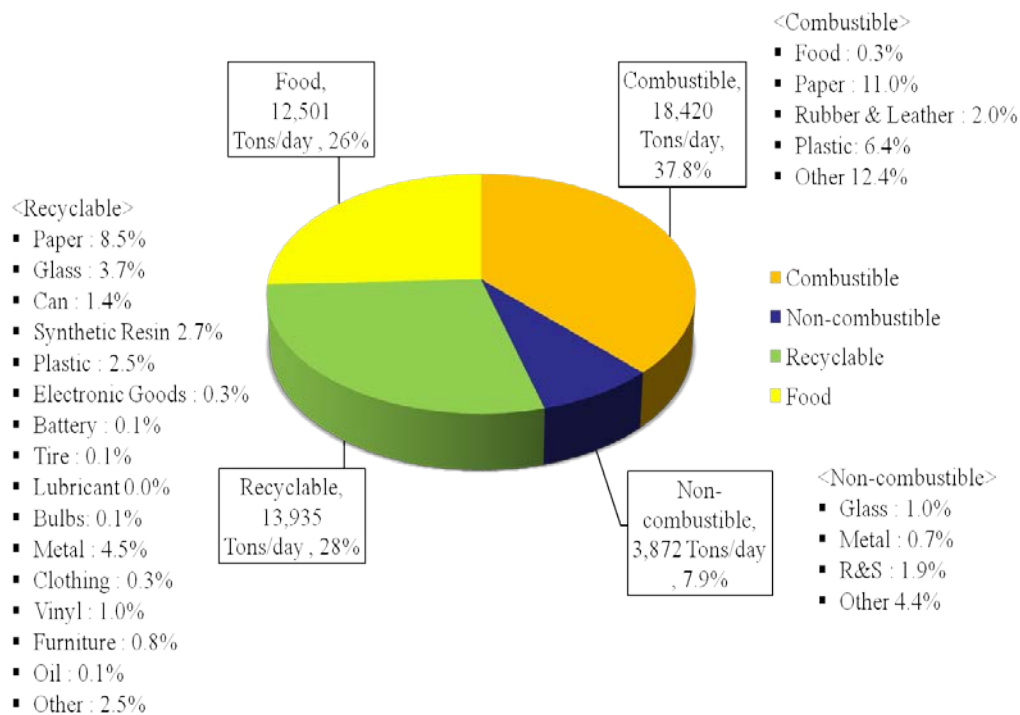

Source: KMOE (2014). 2013 Nationwide *Waste Generation and Disposal Status*. KMOE

2.2.2. Waste Disposal

Looking at the residential wastes by disposal methods for 1999, out of the total of 45,614 tons/day, landfill was largest with 52%, incineration was 38%, recycling was lowest with 10%, but in 2012, out of the total residential waste of 48,990 tons/day, landfill was rapidly reduced to 16%, and recycling rapidly increased with 59%. From 2005, with the ban of burying food wastes and waste separation expanded, recycling increased while influencing the reduction of incineration and landfill.

As the result of the standardized garbage bag system, recycling policy, and waste resource energy conversion implemented from 2000, Korea's waste disposal structure is changing from a simple landfill-oriented system to a resource recirculation system that prioritizes the recirculation of waste resources.

Figure III-5 | Disposal of Residential Waste

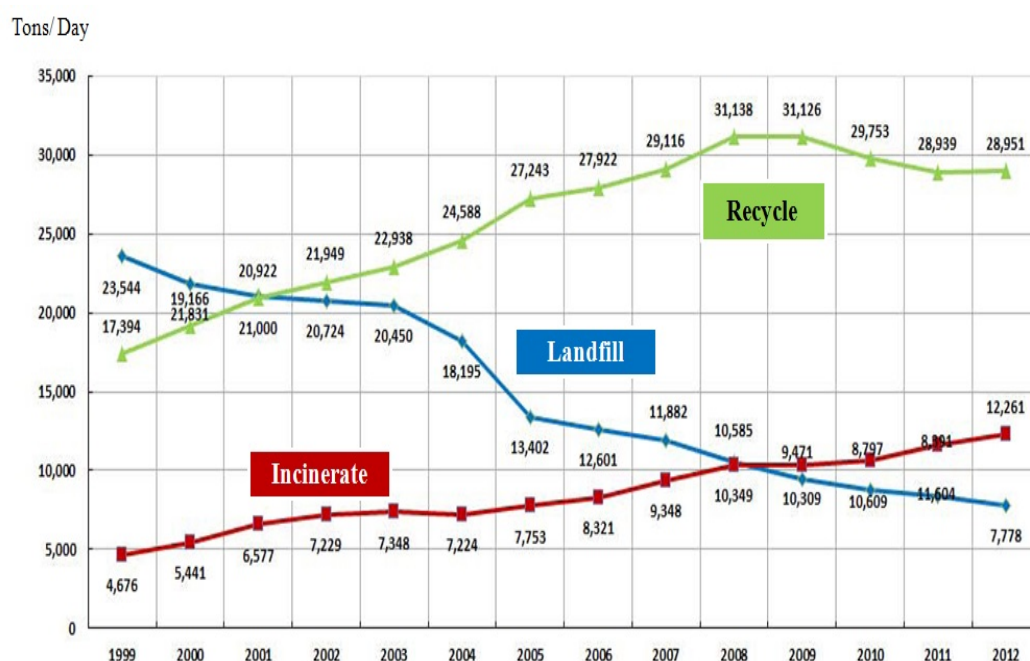

Source: KMOE. (2015). *2014 Environmental White Paper*. KMOE

2.3. Waste Disposal Companies and Facilities

2.3.1. Waste Disposal Companies

If a waste is disposed or recycled in Korea, permission is required under the ‘Waste Controls Act’. The waste disposal business can be categorized into collection and transport, middle disposal, final disposal, and recycling. For the construction waste disposal companies, they need permission for the middle disposal process. There are a total of 12,534 approved waste disposal companies comprising of 6,573 collection and transport companies, 262 middle disposal companies, 55 final disposal companies, 5,146 recycling companies, and 498 middle processing (construction waste) companies. “Middle disposal” and “middle processing” companies are categories only used in Korea which refers to companies performing incomplete processing such as simple shredding, sorting, chemical treatment, etc.

Table III-3 | Waste Disposal Companies

Category	Collection & Transport	Middle Disposal	Final Disposal	Recycling	Middle Processing	Total
Household	1,473					1,473
Emission Facility	2,983	184	38	4,577		7,782
Construction & Demolition	1,495				498	1,993
Special Waste	464	63	17	569		1,113
Medical Waste	158	15				173
Total	6,573	262	55	5,146	498	12,534

Source: KMOE. (2014). *2013 Nationwide Waste and Disposal Status*. KMOE
KMOE. (2014). *2013 Designated Waste and Disposal Status*. KMOE

2.3.2. Waste Disposal Facilities

The waste disposal facilities built and operated by the local governments in Korea are landfills, incineration facilities, food waste recycling facilities, recycling selection facilities, and solid fuel product manufacturing facilities. There are a total of 690 facilities comprising of 233 landfills, 184 incineration facilities, 53 food waste facilities, 66 recycling selection facilities, and 164 others.

Table III-4 | Waste Disposal Facilities by Municipalities

Classification	Landfill	Incineration	Food	Selection	Other	Total
Seoul		5	5	10	26	46
Busan	1	3		2	12	18
Daegu	1	1				2
Incheon	5	9	4	3	5	26
Gwangju	1	1	1	1	5	9
Daejeon	1	1	1		4	7
Ulsan	2	2	1	1	1	7
Sejong	1	1		1		3

Gyeonggi	9	24	13	9	36	91
Gangwon	24	16	1	2	9	52
Choongbuk	13	10	2	4	2	31
Choongnam	16	10	6	5	3	40
Jeonbuk	15	2	1	5	8	31
Jeonnam	58	51	5	7	22	143
Gyeongbuk	38	24	4	6	12	84
Gyeongnam	28	17	7	8	17	77
Jeju	10	7	2	2	2	23
Total	223	184	53	66	164	690

Source: KMOE. (2014). *2013 Nationwide Waste and Disposal Status*. KMOE

2.4. Residential Waste Manpower and Budget

2.4.1. Residential Waste Manpower and Equipment

The collection and disposal of residential wastes can be handled directly by the local governments or consigned to private professional companies in Korea. It is reported that as of 2013, the total number of people handling the collection and disposal of residential wastes are 34,014 people, 11,445 collection trucks, 7,321 handcarts, and 545 heavy equipments.

Table III-5 | Residential Waste Manpower and Equipment

Classification	Persons	Trucks	Handcarts	Heavy Equipment
Total	34,014	11,445	7,321	545
Local Governments	18,577	4,903	5,154	408
Professional Companies	15,425	6,540	2,107	108
Self-Operated Companies	12	2	60	29

Source: KMOE. (2014). *2013 Nationwide Waste and Disposal Status*. KMOE

2.4.2. Residential Waste Budget

The budget needed to install a residential waste disposal facility, operate the trucks, purchase equipment, pay consignment, and operate the facilities as of 2013 was approximately 3.1 trillion won (\$U2.65 billion) and approximately 4 trillion won (U\$3.42 billion) in 2014. Out of the total, consignment fee was the largest with 1.2 trillion won (U\$1.03 billion), 84 billion won (U\$718 million) for labor, and 35 billion won (U\$299 million) for facility operations.

Table III-6 | 2013 Residential Waste Expenditures

Facility Installation	Labor	Truck Operation	Equipment Purchase	Consignment	Facility Operation	Other	Total
297,424	840,043	67,246	29,985	1,273,340	349,189	259,995	3,117,223

Source: KMOE. (2014). *2013 Nationwide Waste and Disposal Status*. KMOE

Table III-7 | 2014 Residential Waste Budget

National Expense	Local Expense	Municipal Bond	Total
165,210	3,248,620	66,054	4,110,786

Source: KMOE. (2014). *2013 Nationwide Waste and Disposal Status*. KMOE

[INTENTIONALLY LEFT BLANK]

3. Case Studies in Korea

3.1. Automatic Pipeline Transport System

In the general case, residential waste are placed in standard garbage bags and discharged in pre-specified locations near the house for curb side service. The main problems for this general process is odor, unpleasant view, flies and other insects, cats which are major causes of claims by residents in the area. A new process and system is currently being implemented in a few areas in Seoul such as the Eunpyung region where an Automatic Pipeline Transport System (APTS) is constructed and being used to solve the above mentioned problems. Test cases were started in 1990 and now in 2015, newly constructed apartment complexes all are equipped with the APTS.

The Figure below show the conceptual idea behind the APTS where residents in the apartment complexes would bring their residential waste to fixed location trash bin and using their pre-assigned RFID cards, residents would open the trash bins with their RFID cards and deposit their waste in the bins. The bins are directly connected to nearby incineration plants via an underground (or above ground) pipelines which uses vacuum suction to automatically transport the deposited waste to the incineration plant where the waste are burned for energy. The APTS eliminates the need for collection trucks and residents can discharge waste at any time of the week without delay.

Figure III-6 | Automatic Pipeline Transport System

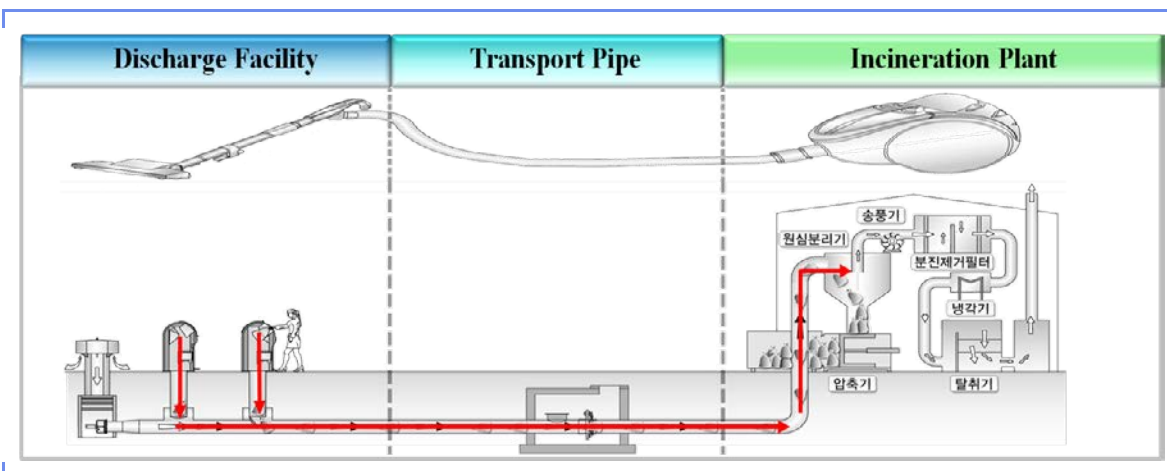

Source: KWEA. (2013). *Automatic Pipeline Transport System*. KWEA

The Figure below show two designs of trash bins used for the APTS.

Figure III-7 | Trash bins for the APTS

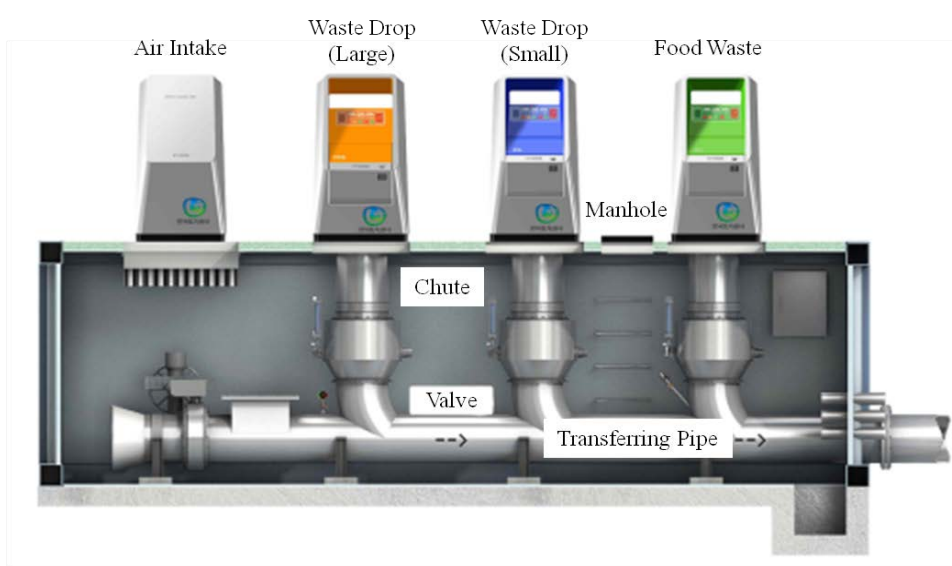

Source: KWEA. (2013). *Automatic Pipeline Transport System*. KWEA

3.2. Allbaro System

Up to the year 2000, all data related to waste collection and disposal were manually recorded and stored. The collection companies recorded collection activities using daily work sheets and disposal companies recorded all disposal activities using a daily log. The manual process was inefficient in using unnecessary time, manpower and effort to perform tasks that could were menial and labor extensive.

In 2001, a computer system called “Allbaro” was implemented in order to automate the data collection, storage, and retrieval process associated with waste collection and disposal data. All collection companies, transportation companies, transfer stations, disposal companies would input daily collection, transportation and disposal data into the Allbaro system online where all waste related data was managed centrally which could be accessed and shared by all stakeholders. Allbaro is the only automatic waste management system in the world that is used by all stakeholders throughout the whole nation. Currently, over 350,000 companies and organizations are using the system and every year over 10 million data activities are processed by the system. The system keeps track of over 128 million tons of waste each year.

Figure III-8 | Waste Information Management System (Allbaro)

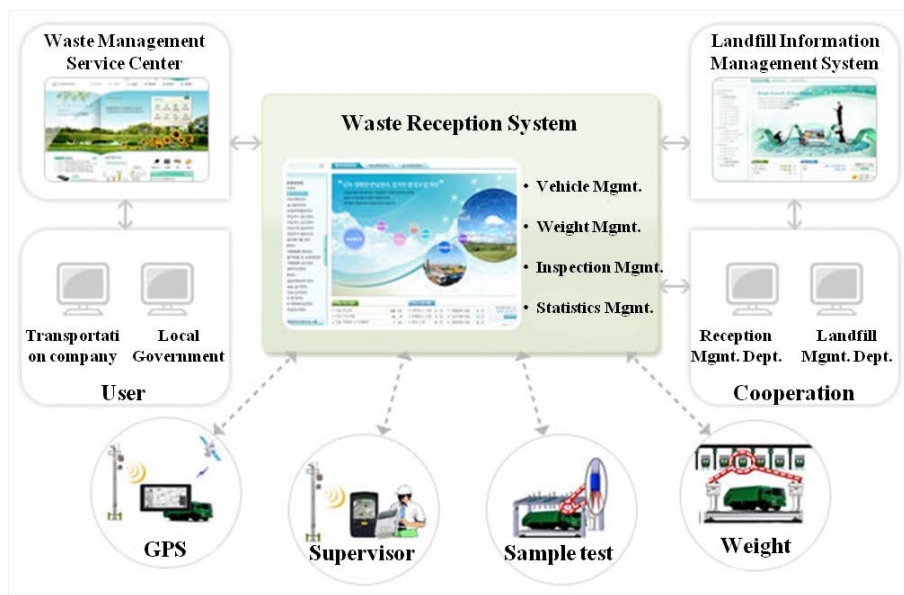

Source: *Allbaro System*. <https://www.allbaro.or.kr>. Oct. 2015

3.3. Medical Waste RFID System

In 2015, in order to properly monitor and manage medical waste which might be hazardous or contagious, the Ministry of Environment issued standardized plastic bins specifically for the storage and transport of medical waste. These plastic bins were tagged using RFID tags in order to track the progress of the waste from the initial discharge to the final disposal.

Figure III-9 | Plastic bins for medical waste with RFID tags



3.4. Use of GPS-based System for Budgeting Purposes

In Korea, almost all the collection and transport activities are outsourced to private waste haulers and in order to accurately determine the necessary budget to contract with the private companies, the local governments estimates the following parameters needed for the collection and transport activities: 1) cost of manpower, 2) cost of truck operations, 3) operational expenses, and 4) management costs. All the other parameters can be estimated using past data; however, in order to estimate the cost of truck operations, we need to know the exact routes taken by the trucks in performing the collection and transport. A GPS-based tracking system can be used to monitor and track the actual routes of the collection trucks operated by the private waste haulers. The Figure below shows one example of such a system used by a local government agency in Korea.

Figure III-10 | Example of the GPS-based Tracking System

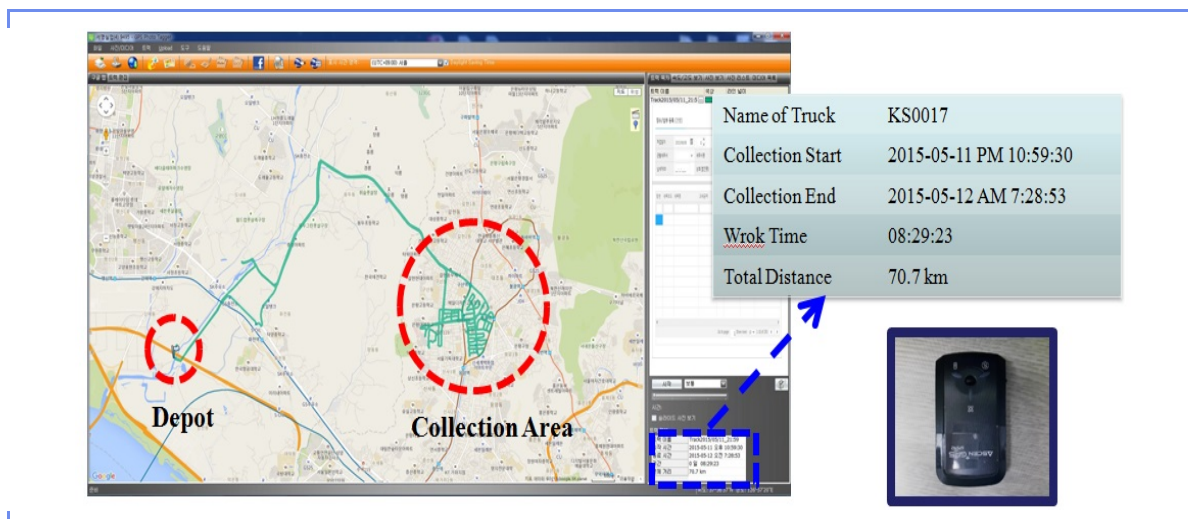

3.5. Residential Waste and Disposal

3.5.1. Separation and Disposal of Residential Waste

Residential waste is separated at the point of discharge depending on the composition of the waste. Combustible wastes and incombustible wastes are separated and discharged in their respective standardized garbage bags. There are no special criteria for recyclable wastes, but they are discharged in transparent bags that

make it easy to confirm the contents inside the transparent bags. Large garbage is classified as used furniture and used household appliances, where stickers have to be purchased at the local district offices and put on the discharged furniture before they can be collected, while the discharged household appliances are collected free of charge if they are properly reported to the local district office.

3.5.2. Types of Trucks for the Collection and Transportation of Residential Wastes

The trucks for collecting and transporting of residential wastes differ depending on the type of garbage. Combustible wastes are generally transported by compressor trucks, and if the distance between the collection site and disposal depot is far, they are sometimes transferred to an “arm-roll” truck at a transfer station and before being transported to the disposal depot.

Figure III-11 | Types fo Trucks



Food wastes are transported with tank-lorries made exclusively for this purpose and these trucks are equipped with mechanical devices on the front or side of the trucks to load the special food waste containers. Recyclable wastes are mostly transported in cargo trucks that can unload in ‘dumping’ style. These trucks usually have high sides and an open-top. However, the recent trend for the recyclable waste trucks is renovating them by closing off the top for safety and for environmental reasons. Bulky wastes, such as used household appliances, are transported with

“Wing-Body” trucks that open sideways or topside, while cargo trucks with open tops are used for furniture.

3.5.3. Residential Waste Disposal Methods

In general, residential wastes are disposed of by incineration, landfill, re-utilization or recycling. There are currently approximately 500 incineration facilities in Korea, where most of the medium and large incineration facilities recycle the heat to produce hot water or electricity (waste-to-energy plants). The incineration facilities are managed in accordance with the installation, management, and inspection standards of the Waste Management Law, and the emitted gas is managed strictly by the air quality standards of the Law. The Stoker-type incinerators are mostly used in Korea because of their efficiency and proven technology. However, various other types such as the Fluidized Bed, Rotary Kiln, Gasification, and Plasma were all considered with few currently in operation.

There are about 290 landfills in Korea, where 220 are public facilities. The landfill facilities are operated in accordance with the installation, maintenance and follow-up standards for dikes, shield skirts, leachate treatment sites, underground water control, gas pileup facilities, etc. accordance to the Waste Management Law. The largest landfill is the Metropolitan Landfill which is in the vicinity of Seoul and handles the wastes generated in Seoul, Incheon and the Gyeonggi Province.

Food wastes are mostly handled by the three facilities comprised of the Compost Facility, the Fodder Facility, and the Anaerobic Digestion Facility. With the establishment of the Landfill Prohibition Law in 2005, the food waste treatment facilities increased to 280 nationwide, and they are being managed by the Waste Management Law together with the incineration facilities and the landfills.

Recyclable wastes consist of glass bottles, metal cans, plastics, papers, vinyls, and styrofoams that can be reused or recycled. They are transported to the recyclables sorting facility in their mixed state at the time of the collections, and then separated into various materials by people or machines. There are some 200 public and private sorting facilities in Korea, and the separated materials are then auctioned and sold to various recycling companies.

The SRF (Solid Refuse Fuel) Facility is an energy recovering facility that emerged as the substitute for the incineration facilities. SRF is also called the RDF (Refuse Derived Fuel) in the past. The SRF Facility produces solid refuse fuel in ‘pellet’ or ‘fluff’ form by crushing, grinding, drying and shaping the combustible wastes, and these wastes are used as natural fuels in cogeneration plants, cement kilns, and industrial boilers after the contaminants are removed and heat is increased.

3.5.4. Residential Waste Management in the City of Seoul

1) Residential Wastes and Disposal

Seoul, the Capital City of the Republic of Korea, has an area of 605km², and a population of approximately 10.40 million people. It is a large city with 25 administrative districts and generates an average of about 8,559 tons (as of 2012) of residential wastes daily, with each person generating 0.8kg a day. With the Standardized Garbage Bag System implemented in 1994, the residential wastes decreased by 40% compared to 2012, and landfill was reduced to 94%.

Figure III-12 | Trend in Waste Generation and Burial in Seoul

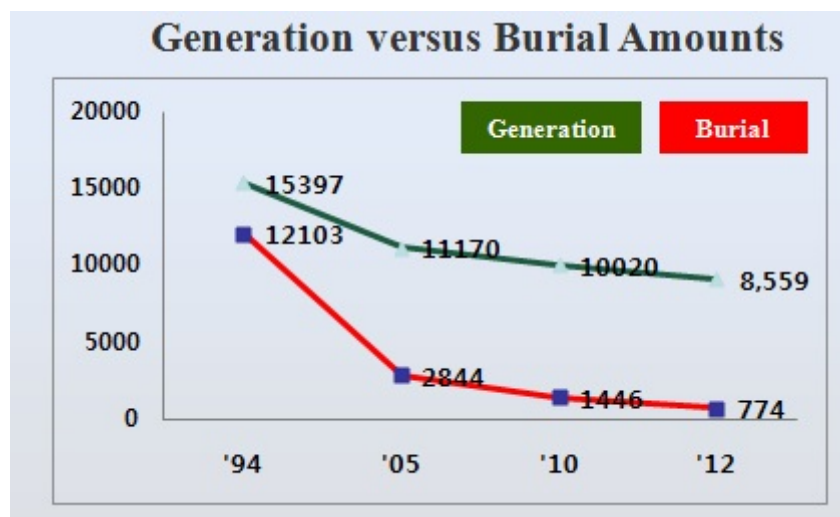

Source: Yu. (2015). *Policy on Waste Management in Seoul*. City of Seoul

Based on the 2012 residential wastes, general garbage was 3,078 tons (36%), food waste was 3,072 tons (35.9%), and recyclable waste was 2,409 tons (28.1%). From this amount, 2,304 tons (42%) were incinerated, 774 tons (14.1%) were landfilled, and

5,481 tons (43.9%) were recycled, making recycling the most used method for waste treatment.

2) Residential Waste Collection and Disposal System

Residential waste is separated into general waste and recyclable waste, and general waste is collected by the local governments and transported to the incineration facilities and landfills. There are five incineration facilities in Seoul, and only one landfill, the Metropolitan Landfill. Recyclable wastes are collected by both the local governments and private recycling waste collection companies. The local governments transport to the recyclables sorting center where they are auctioned off after the EPR registration, while private collectors work directly with the recycling companies. Food wastes are collected by the local governments and directly contracted with recycling companies in Seoul and its vicinity.

3) Residential Waste Collection and Management Infrastructure

The collection and transportation of residential wastes and the management of street sweeping for the city of Seoul are differentiated. In the case of collecting and transporting, most of the local district offices work independently by contracting the jobs to third parties while operating with the income from the selling of standardized garbage bags. There are 3,018 sanitation workers cleaning from 19:00 until 05:00 daily.

Table III-8 Residential Waste Collection and Management Infrastructure in Seoul

Category	Collection & Transportation	Street Sweeping
Responsible Party	Contractor	Local District Office
Number of Sanitation Workers	3,018 people	2,559 people
Cleaning Time	19:00 ~ 05:00	05:00 ~ 15:00
Operation	Independent	Local District Office

Source: City of Seoul. (2015). *Report on Resource Circulation*. City of Seoul

The street sweeping is handled by the local district offices with 2,559 workers cleaning from 05:00 until 15:00 every day.

There are a total of 1,953 trucks for collecting and transporting general household and food wastes in Seoul. General wastes are usually collected by compression trucks, cargo trucks and “arm-roll” trucks, while food wastes are collected by specially designed and manufactured food-waste collection trucks.

3.5.5. City of Busan’s Formation of the Eco-Friendly Energy Town

1) Residential Wastes and Management

Busan is 769km² in area with a population of about 3.56 million people, and divided into 16 administrative districts. Based on the 2014 figures, there were 3,258 tons/day of residential wastes generated composed of 1,030 tons of general wastes, 780 tons of food wastes, and 1,448 tons of recyclable wastes. From these wastes, 1,448 tons were recycled, 961 tons were incinerated, 69 tons were landfilled, and 780 tons of food was recycled, making recycling the highest treatment method.

Table III-9 | Waste Generation and Treatment in Busan

Year	Generated (tons/day)				Treated (tons/day)				
	Total	General Wastes	Total	General Wastes	Total	General Wastes	Total	General Wastes	Total
2014	3,258	1,030	780	1,448	3,258	1,448	961	69	780
2013	3,174	1,004	759	1,411	3,174	1,411	771	233	759

Source: City of Busan. (2015). *Report on Resource Circulation*. City of Busan

2) Residential Waste Treatment Facilities

The collection and management infrastructure of Busan’s residential wastes are summarized in Table 22 with 3,047 people for collection and 1,044 trucks for cleaning. In terms of facilities, there are one landfill, two incineration facilities, one SRF facility, 15 recycling facilities, 116 recycling centers, seven food recycling facilities, and 394 waste treatment companies.

Table III-10 | Residential Waste Collection and Management Infrastructure in Busan

Category	Manpower and Facilities
Cleaning Manpower	<ul style="list-style-type: none"> • 3,047 sanitation workers
Cleaning Trucks	<ul style="list-style-type: none"> • 1,044
Landfill	<ul style="list-style-type: none"> • Area: 748,000m², Capacity: 24,494,000m³
Incineration Facilities	<ul style="list-style-type: none"> • 2 (Myeongji, Haeundae) 510 tons/day
SRF Facility	<ul style="list-style-type: none"> • SRF Production Facility: 900 tons/day, Boiler Facility: 500tons/day, Power: 24.8MWh
Recycling Facilities	<ul style="list-style-type: none"> • 15 Sorting Centers, 116 Recycling Centers
Food Recycling Facilities	<ul style="list-style-type: none"> • 7 (2 public, 3 private, 2 local government) 964 tons/day
Waste Treatment Companies	<ul style="list-style-type: none"> • 394 (356 collect & transport, 38 mid-process, 2 final process)

Source: City of Busan. (2015). *Report on Resource Circulation*. City of Busan

3) The Busan Eco-Friendly Energy Town

The infrastructure for Busan’s residential waste disposal system is concentrated around the Saengok Landfill in Gangseo-gu, and the facilities mutually link together and reuse the energy generated from the waste treating process. The City of Busan is currently building an eco-friendly energy town to this infrastructure by adding a Specialized Resource Recirculation Complex.

The ‘Eco-Friendly Energy Town’ is a project that will solve the environmental and energy problem simultaneously by installing avoiding facilities like the landfill, sewage treatment plant, and incineration facility in one location and providing the local residents with actual benefits. The City of Busan plans to not only provide the residents with jobs, energy supply and improved welfare, but also expand their project into a culture and tourism business to overcome the general view of avoiding unpleasant facilities.

The LandFill Gas (LFG) generated from the Saengok Landfill produces 4MWh of electricity from the generator facility built with private investment and records an

annual income of KW2 billion (\$1.7 million), while the food recycling facility produces 2MWh of electricity from collected digestion gas. The SRF facility produces SRF from 900 tons of waste daily and the boiler facility uses this to generate 24.8MWh of electricity, bringing in KW15.9 billion (\$13.6 million) in profits annually. Additionally, the Sewer Sludge Recycling Facility, the Recycling Center, the Recyclable Sorting Facility, the Vinyl Recycling Facility, and the Vinyl SRF Facility are also being used as eco-friendly facilities to recycle resources and collect energy, and the earnings from the Eco-Friendly Energy Town are being used for the local community after discussions with the local resident task force committee. Furthermore, the Special Resource Recirculation Complex that is being formed as part of the Governmental Assistance Policy is scheduled to be completed in December 2015, with the hope of attracting 77 private steel scrap and waste recycling companies, and creating some 3,000 jobs. The Complex plans to build the foundation for the recycling industry by creating a synergy effect of mutually linked companies of the recycling industry in one concentrated area.

Figure III-13 | Busan Eco-Friendly Energy Town

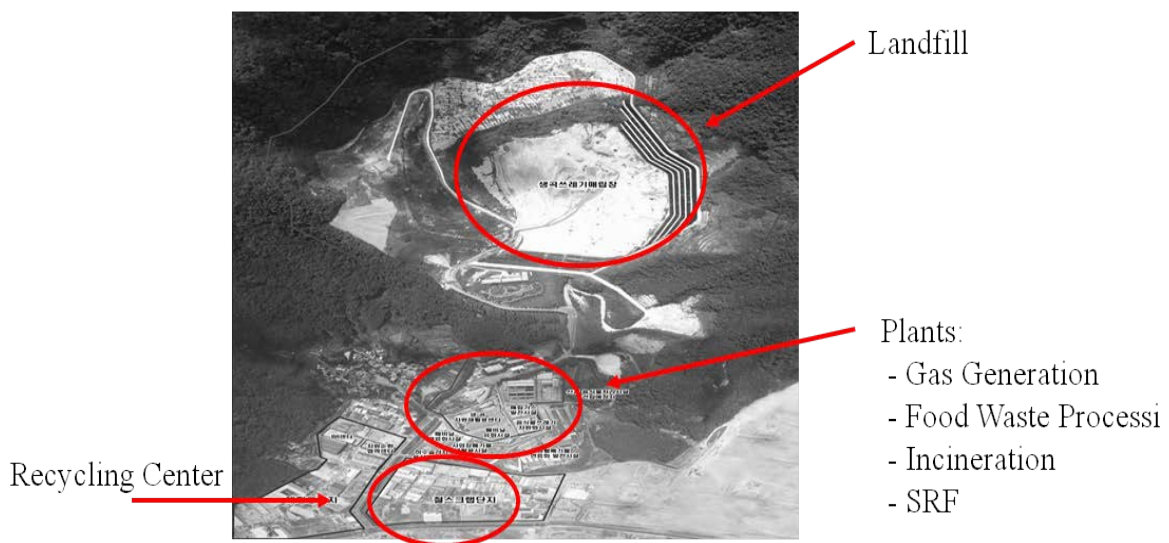

Source: City of Busan. (2015). *Best Practice: Busan Eco-Friendly Energy Town*. City of Busan

3.5.6. The Metropolitan Landfill and Plans for the Futuristic Theme Park

1) Metropolitan Landfill Facility

The Metropolitan Landfill was formed in 1992 and located in Seo-gu, Incheon to treat the residential and construction wastes generated in Seoul, Incheon and part of the Gyeonggi Province. It has an area of 15,410,000 m² with the capacity of 228 million tons. It is comprised of four zones, with Zone 1 currently being used as a golf course after the area was filled completely. Zone 2 is currently in use, with Zones 3 and 4 remaining in reserve.

Figure III-14 | Current Status of Metropolitan Landfill

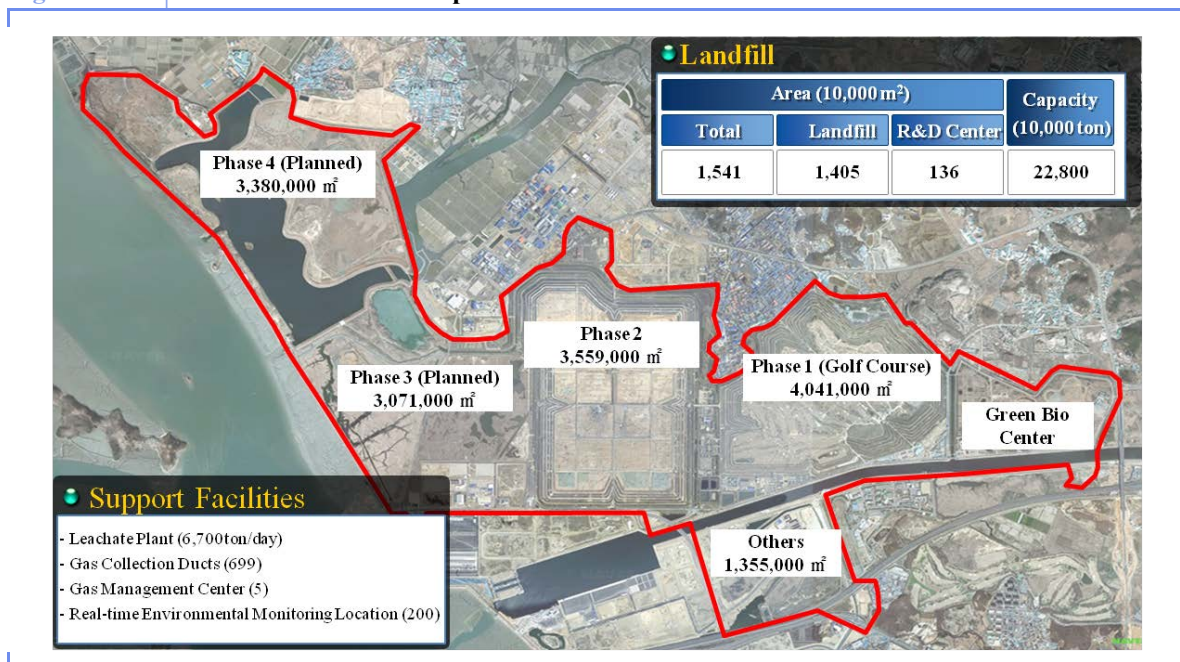

Source: SLC. (2015). *Development of Eco-Friendly Energy Town*. SLC

2) Eco-Friendly Metropolitan Landfill Energy Town

The Metropolitan Landfill is managed by the Metropolitan Landfill Site Management Corporation that was established by the Korean government to handle the wastes from the initial two cities and one province. In the beginning, the Corporation was planned to manage the landfill site only, but with the change in the waste policies and the times, it is now managing a variety of energy facilities additionally.

In accordance with the government's changed policy to reduce wastes and recycle more, the inflow of wastes to the Metropolitan Landfill was drastically reduced after 1994 from 11.7 million tons to 3.45 million tons in 2013, almost below 1/3. Taking into consideration the recent increase in oil prices and the basic conditions for utilizing energy, the formation of an eco-friendly energy town was planned from the end of the 1990s. The eco-friendly energy town was formed because there were infrastructures for the new towns and industrial complexes to supply heat and electricity near the vicinity of the Metropolitan Landfill, and there were a lot of combustible and organic wastes coming into the landfill that could be utilized for energy.

The Metropolitan Landfill Eco-friendly Energy Town uses the LFG from the landfill to produce 50MWh of electricity, the largest amount of its kind in the world, and operates a 200 ton/day SRF facility, with 25,000Nm³ of bio gas (methane content of more than 60%) from anaerobic digestion of the food waste water. In addition, the Town is equipped with a sewer sludge dry fuel facility (1,000 tons/day), a bio gas automobile fuel facility (10 m³/minute), a bio circulation forest, a resource recirculation research center and training facility, an international exhibition hall and convention facility.

3) Plans of the Metropolitan Landfill Futuristic Theme Park

The Metropolitan Landfill plans to go beyond its status of being the largest landfill and eco-friendly energy town, to form a global theme park and resort of the future. The goal of this project is to contribute to the activation of Incheon's economy and national development by forming a multi-resort complex with a variety of contents including environmental, touristic, leisure, recreational, cultural, amusement, and commercial.

[INTENTIONALLY LEFT BLANK]

Figure III-15 | Plan for Future Them Park



Source: SLC. (2015). *Development of Eco-Friendly Energy Town*. SLC

The multi-resort theme park will be developed on 5,400,000 m² of land which includes the Zone 1 landfill and will house a Park & Resort Area, Golf & Healing Area, and an Urban Entertainment Center (an urban cultural facility).

The Park & Resort will be 870,000 m² in area comprised of a theme park, a water park and condominiums for both the young and the old to enjoy together, while the Golf & Healing area will be 3,000,000 m² and incorporate the golf course that is already in use with a healthcare town with state-of-the-arts medical equipment to be built. The Urban Entertainment Center will be 1,300,000 m² and will house a shopping mall, outlets and hotels.

The Metropolitan Landfill hopes to take the second leap in development with the formation of the futuristic theme park, taking into consideration the regional advantages and conditions of the times.

IV. Recommendation

1. Recommendation for Number of Operational Trucks

1.1. Evaluation Method for Collection Efficiency

1.1.1. MHT (Man Hour per Ton)

MHT is the man hour needed to collect one ton of waste, that is to say, the amount of time needed for one man to collect one ton of garbage. This number changes depending on the location of the garbage bin, distance, type and shape of the garbage bin, and the ability and type of the collection truck. In other words, the MHT is the direct variable that represents the collection efficiency.

According to Dr. Tchobanoglos in “Waste Treatment and Disposal”, the garbage bag collection method involving the disposable garbage containers was the most efficient with 0.9 MHT, the usual street collection was 1.6 MHT, and the ‘set out’, ‘set out & set back’, and ‘back yard carry’ where the sanitation workers had to go indoors several times to bring out the wastes were the most labor-intensive with 2.6 MHT. Normally, based on the level of MHT equal to 1.0, collection efficiency is considered good if it is below this number, and poor if it is above. However, this MHT value is the official time-expense estimation of the sanitation workers, so the number can be reduced if the waste generation is coordinated amongst households.

Table IV-1 | General MHT Dependent on Type of Container and Location of Collection

Category	Plastic Bags		Movable		Fixed		
	Outdoors	Indoors	Outdoors	Indoors	Outdoors	Indoors	Fixed
Actual Collection		0.12	0.24	0.63	0.73	1.01	1.16
Other *		1.23	1.23	1.23	1.23	1.23	1.23
Total		1.35	1.47	1.86	1.96	2.24	2.38

※ In “Other”, the time in-between collections, time to and from transfer stations, and time for unloading at the transfer station are all included.

Source: Min, et al. (2003). *Waste Disposal Engineering*. Sae-Hwa Publishers

Table IV-2 | MHT Value for Collection Service

Collection Method	Characteristics	Remark	
Bin Collection	Alley Collection	Households located inside an alley bring their garbage bins to the collection truck on the street when they hear the collection bell and take the empty bins back.	1.6 MHT
	Curb Collection	The collection truck empties the garbage bins located on the curb on a designated day and the owners take their empty bins back.	
	Block Collection	The collection truck passes by on a designated route at a designated time signaling or ringing a bell, and the households bring their garbage bins to the collection truck. It is the same as the 'bell ringing' collection.	
	Set Out	The collector comes into the houses to take the garbage bins out to the collection truck and the owners bring their empty bins back.	
	Set Out – Set Back	Similar to the 'Set Out' method, but the empty garbage bins are brought back by the collector.	2.6 MHT
	Back Yard Carry	The collector comes into the house to collect wastes from a fixed garbage container (more than 35 liters and less than 20kg).	
Poly Bucket	Container collection method for industrial wastes.	0.9 MHT	
Bag Collection	For medium and small cities. Waste is collected in bags. Cost savings.		
Dust Box Method	Boxes are installed on the street per tens of households and the collection truck takes them.		
Chute Method	Chutes are installed on the walls of apartments or buildings.		
Container Collection	Waste is stored on the lowest floor after being collected by the Chutes.		

Source: Min, et al. (2003). *Waste Disposal Engineering*. Sae-Hwa Publishers

1.1.2. The Time-Motion Study

The Time-Motion Study is a research done on the time it takes for the collection trucks or carts to leave the depot until they return with a full load. In this case also, the value changes depending on the location of the garbage bin, the distance, the type and shape of the garbage bin, the ability and type of the collection truck, the type of residence and the distance between the collections. Like the MHT value, the

collection time is determined depending on the type and location of the garbage bin, and the actual collection time is used to influence the overall collection time. Therefore, it can be understood that in order to reduce the collection time, it is advisable to install movable rather than fixed garbage bins, outdoors instead of indoors, and the best collection method is the ‘Bag’ method like the standardized garbage bags.

The Time-Motion Study can be explained as follows, and this data is used to determine the collection efficiency factor:

- services/day/truck : number of houses per day per truck
- services/man/hr : number of houses per man per hour
- tons/day/truck : collection volume per day per truck
- tons/man/hr : collection volume per man per hour

Table IV-3 | Time-Motion Study Dependent on Type of Container

Category	Plastic Bags	Movable		Fixed		Wall Attachment
		Outdoors	Indoors	Outdoors	Indoors	
Actual Collection Time	3.7	7.4	19.6	22.7	31.4	35.9
Travel Time During Collection	4.8	4.8	4.8	4.8	4.8	4.8
Travel Time To Transshipment Depot	15.2	15.2	15.2	15.2	15.2	15.2
Unloading Time at Transshipment Depot	12.8	12.8	12.8	12.8	12.8	12.8
Other	5.4	5.4	5.4	5.4	5.4	5.4
(Total)	41.9	45.6	57.8	60.9	69.6	74.1

1.2. Time-Motion Study in Barbados

1.2.1. Route Selection for the Time-Motion Study

In terms of waste disposal collection, Barbados is divided into five regions of North, South East, South West, City East, and City West. Taking into consideration the distance between the regions, two depots, the Wildey Depot in the south and the North Depot in the north are in operation for the garbage trucks. While the Wildey

Depot is responsible for collecting wastes from four out of the five regions of South East, South West, City East and City West, the North Depot is only responsible for the North region.

For the Time-Motion Study, two routes of South East and City West were selected from the Wildey Depot. Route 1 used the ML 271 collection truck with the capacity of 14.25 tons. The ML 271 left the garage at Wildey Depot, collected the wastes at South East’s Mangrove Ocean City Foul Bay, unloaded at the SBRC Landfill and returned to the Depot. Route 2 used the ML 278 collection truck with the capacity of 5.92 tons. The truck left Wildey Depot for the Bridge Town Farm Road at City West to collect the wastes, unloaded at the SBRC Landfill and also returned to the Depot.

Figure IV-1 | Time-Motion Study Routes

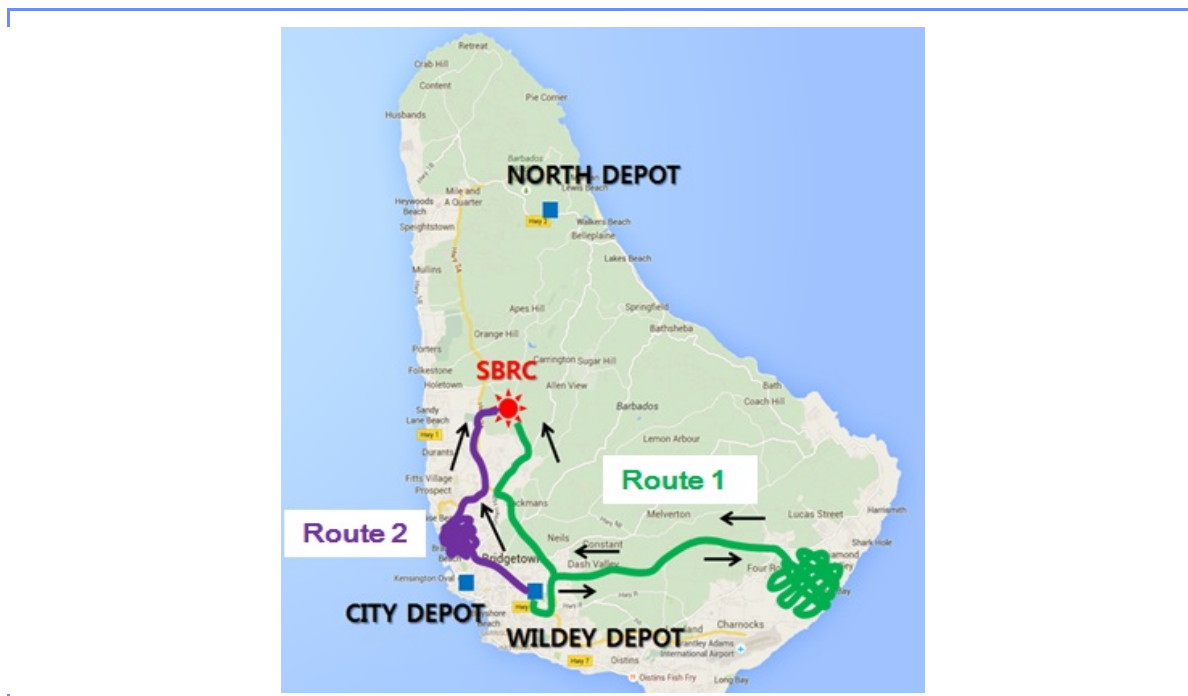

▷ Route 1 [ML 271 truck]

Wildey Depot (garage) ⇒ South East Region (four roads ⇒ Mangrove Ocean City Foul Bay) ⇒ SBRC (landfill) ⇒ Wildey Depot (return to garage)

▷ Route 2 [ML 278 truck]

Wildey Depot (garage) ⇒ City West Region (near Bridge Town Farm Road) ⇒ SBRC (landfill) ⇒ City West Region (return to site)

1.2.2. Main Parameters of the Time-Motion Study

The measured values for the two routes are showed in Figure IV-1 (above). A compactor truck with a driver and two loaders were involved in the Study. While most of the countries use high performance small trucks for collection and large container-type trucks for transportation, Barbados uses small compactor trucks for both collection and transportation. This is because the overall waste transportation distance in Barbados is short.

For Route 1, the collection site was 14km (19 minutes) from the Depot, and a total of 10.66 tons of waste was collected from 372 pickups, travelling 14km (299 minutes) within the collection region. The collected wastes were taken to the landfill and then the truck returned to the Depot. Leaving from the Depot and returning back after the collection took a total of 395 minutes and the distance traveled of 67km. In the case of Route 1 travelled by the ML 271 truck, the time for one collection was 6.6 hours, and it was the route that had the 1 trip/day collection frequency so it is recommended that a large truck be used for the long distances.

In Route 2, the travel distance was 5km (11 minutes) from the Depot to the collection site, and a total of 4.72 tons of waste was collected travelling 4km (111 minutes) within the collection site, making 105 pickups. The collected wastes were taken to the landfill and then the truck returned to the collection site to collect the second batch of collection for the day. Leaving from the Depot and returning back after the collection took a total of 173 minutes, and the total distance traveled was 28km. For Route 2 where the compact short distance truck ML 278 was used, the time for one collection was 2.9 hours, and it is the route with the collection frequency of 2 or 3 trips/day.

[INTENTIONALLY LEFT BLANK]

Figure IV-2 Parameters for the Time-Motion Study

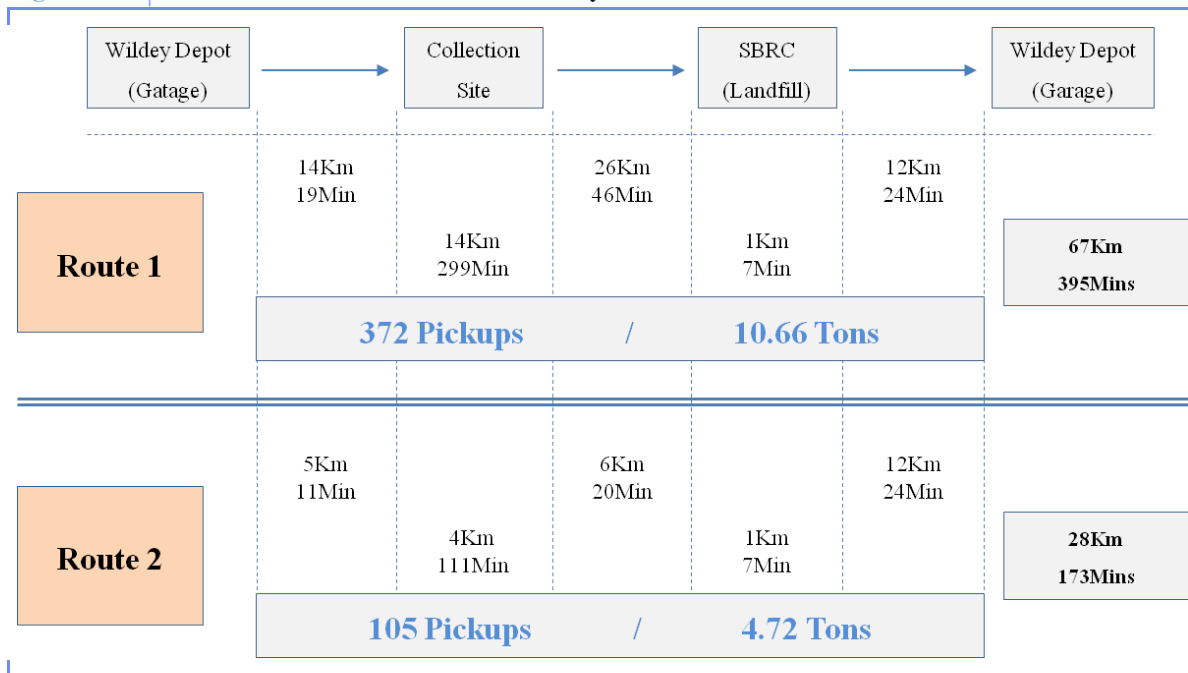

1.2.3. Major Results of the Time-Motion Study

All major deducible results of the Time-Motion Study are presented in Figure IV-2 (above). The MHT, the most important numeric value in this study, was 1.84 man hour/ton which was slightly higher than the average for the outdoor movable or alley collection methods but indicated that a comparably efficient collection was taking place. However, the time it takes to collect one ton of waste was reduced by more than 1.4 times the standard collection, indicating that the loaders were very efficient.

As Route 1 and Route 2 were performed one outside the city center and one in the downtown (concentrated) area using either a large truck or a compactor truck respectively, the results of the Time-Motion Study is somewhat different. In the case of the city center where there is a densely concentrated population, the time it took to collect one ton of waste was less than outside the city center, but the volume per collection and time per collection was more than outside the city center.

Table IV-4 | Analysis of Time-Motion Study in Barbados

Index		Route 1	Route 2
No. of Operators		1 driver + 2 loaders	1 driver + 2 loaders
Vehicle	Type	compactor truck	compactor truck
	Capacity	14.25 tons	5.90 tons
Distance (km)	Travel	53 km	24 km
	Collect	14 km	4 km
	(Total)	67 km	28 km
Operation Time (hr/cycle)	Traveling	1.60	1.03
	Collecting	4.98 (Ⓣ 1.40 © 3.58)	1.85 Ⓣ 0.40 © 1.45)
	(Total)	6.58	2.88
No. of Pick-ups		372	105
Loads		10.66 ton	4.72 ton
Actual Loading to Truck Capacity Ratio		0.748	0.800
Operating Time Per Ton		0.617 hr/ton	0.610 hr/ton
Collection Time Per Ton	Total	0.467 hr/ton	0.392 hr/ton
	Net	0.336 hr/ton	0.307 hr/ton
Collecting Efficiency (MHT)		1.85 man·hr/ton	1.83 man·hr/ton
Collection/Pick-up	Per Pick-up	28.65 kg/pick-up	44.95 kg/pick-up
Collection Time/Pick-up		0.80 min/pick-up	1.06 min/pick-up
Net Collection Time/Pick-up		0.58 min/pick-up	0.83 min/pick-up
Operation Time/Collection Time		1.321	1.557

Ⓣ Travel Time within the Collection Region, © Actual Collection Time

Table IV-5 | Time Required to Collect One Ton of Waste by Bin-type

Moveable Bins		Fixed Bins		Wall Attachments
Outdoors	Indoors	Outdoors	Indoors	Indoors
45.6 min./ton	57.8 min./ton	60.9 min./ton	69.6 min./ton	74.0 min./ton

1.3. Estimation of the Required Number of Collection Trucks

It is possible to estimate the total number of trucks needed for waste transport in Barbados using the annual waste collection results or the results from the Time-Motion Study directly, and to determine the appropriate number using the complex economic feasibility evaluation.

The total waste collected in Barbados for 2014 was 184 tons/day, and in order to estimate the required number of trucks to collect this volume, several preconditions must be met. In other words, it will be assumed that the total waste collection is 200 tons/day, work hours are five days/week at eight hours/day, and the collection trucks will be used for waste collection and transportation only.

◇ Assumption

- work 8 hrs/day & 5 days/week
- need to collect 200 tons of waste per day
(which is about 10% over the current average of 184 tons per day)
- # of trucks = trucks used only for collection & transportation

1.3.1. Calculation using the 2014 Barbados Waste Management Results

When reviewing the 2014 cleaning operations data for Barbados, it was recorded that the trucks made about two trips a day to the landfill bringing in five tons per trip. Accordingly, it was stated that 20 trucks were used to do this daily. Taking into

consideration that Barbados currently operates 53% of its trucks, it can be estimated that 38 trucks are needed.

Number of trucks needed optimally

$$= 200 \text{ ton/day} \div [5.00 \text{ ton/trip} \times 2 \text{ trips/truck}]$$

$$= 20 \text{ truck/day}$$

Actual number of trucks needed using the defect ratio

$$= 20 \text{ trucks} \div 53\%$$

$$= 38 \text{ trucks/day}$$

1.3.2. Calculation using the Results of the MHT Directly

The waste collection trucks work 8 hours a day with a team of three people per truck and the planned collection of 200 tons per day. So if the MHT value is adjusted accordingly, the number of trucks needed is 16. If the current truck defect rate of Barbados (53%) is considered, then 30 trucks are needed.

To collect 200 tons/day,

$$\text{MHT} = 1.84 \text{ man}\cdot\text{hrs/ton}$$

$$= 368 \text{ man}\cdot\text{hrs}/200 \text{ tons}$$

$$= 46 \text{ men}\cdot 8 \text{ hrs}/200 \text{ tons}$$

$$\doteq 16 (3 \text{ men}) \times (8 \text{ hrs})/200 \text{ tons}$$

$$= 16 \text{ trucks}\cdot\text{day}/200 \text{ tons}$$

Actual number of trucks needed using the defect ratio

$$= 16 \text{ trucks} \div 53\%$$

$$= 30 \text{ trucks/day}$$

1.3.3. Calculation Reflecting the Economic Feasibility

This method is applied when planning for the number of trucks needed during the initial stages of operation or when planning to buy medium or large quantities of trucks during regular operations. This method is used to determine how many and what

capacity trucks need to be purchased. However, instead of deciding the capacity through planning, it is expertly determined using the road structure and collection situation in many instances. Therefore, this method is suggested as a general recommendation instead of explaining the current situation of Barbados.

In order to decide on how many and what capacity trucks are needed, it is necessary to apply the method on a variety of trucks. First of all, a table is made with random volumes on the vertical using the results of the Time-Motion Study or the annual operation results for Barbados, where 2, 4, 6, 8..., 18, 20 tons of waste volume is selected. In Table IV-6, 0.77 was used as the actual volume by averaging the load ratio of Table IV-4. Next, the total driving time of Table 4-4 is proportionally considered and collection frequency for one day (8 hours) is calculated for each truck capacity. Therefore, the actual load volume multiplied by collection frequency will be the collection capacity per truck.

The overall collection volume is estimated as $10.78N_2 + 12.32N_4 + 13.86N_6 + 15.40N_{10} + 10.78N_{14}$. In Table 4-6, the 8-ton and 12-ton trucks appear to have less collection volume overall compared to the other trucks with the same collection frequency, so they seem to be inefficient, while the trucks with a capacity for more than 16 tons appear to have less than one collection per day, so they need to be utilized for other special purposes rather than for regular waste collections. Taking into consideration the current waste collection situation in Barbados, it appears that the trucks needed are the 2-tonners, 4-tonners, 6-tonners, 10-tonners and 14-tonners.

Table IV-6 | Step 2 - Determining the Total Collection Weight

Truck Capacity (tons)	Actual Loading Weight ^(*1) (tons)	Trip Per Day ^(*2) (trips/day)	Waste Collected (tons/day)	Required Truck Quantity	Total Waste Collected
2	1.54	7	10.78	N_2	$10.78N_2$
4	3.08	4	12.32	N_4	$12.32N_4$
6	4.62	3	13.86	N_6	$13.86N_6$
8	6.16	2	12.32	low efficiency	-
10	7.70	2	15.40	N_{10}	$15.40N_{10}$
12	9.24	1	9.24	low efficiency	-
14	10.78	1	10.78	N_{14}	$10.78N_{14}$

Truck Capacity (tons)	Actual Loading Weight ^(*1) (tons)	Trip Per Day ^(*2) (trips/day)	Waste Collected (tons/day)	Required Truck Quantity	Total Waste Collected
16	12.32	below 1	12.32	special purpose	-
18	13.86	below 1	13.00	special purpose	-
20	15.40	below 1	13.00	special purpose	-

(*1) using the average of about 77%

(*2) based on 8 hrs (1 day) ÷ operation time (hr/cycle) by the results of the time-motion study [see Table IV-4]

For Step 2, the total volume of waste collected by the different capacity trucks in Step 1 must be over 200 tons per day. For this purpose, the following equation must be analyzed, and the result will be presented with numerous values. The maximum value for N is the total number of the various volume trucks used per collection. The number of trucks needed by load capacity to collect 200 tons a day is 18 2-tonners, 17 4-tonners, 15 6-tonners, 13 10-tonners, and 18 14-tonners.

$$10.78N_2 + 12.32N_4 + 13.86N_6 + 15.40N_{10} + 10.78N_{14} \geq 200\text{tons/day}$$

⇒ many solutions are suggested

In the last step, the total cost per truck per day is calculated by using the number of trucks needed per capacity in Step 2 and multiplying the daily cost of the truck (\$ BD/day). The daily cost of the truck is calculated by adding the operation cost of the truck (\$ BD/day) such as purchase price depreciation, repair costs, and fuel costs, taking into consideration the durability life of each truck. The lower the expense the more economical, so using trucks with various capacities is the most economical method.

Table IV-7 | Step 3 – Calculating the Total Cost & Selecting the Truck Capacity and Quantity

Alternative No.	(1) Required Truck Quantity					(2) cost ^(*1) (\$ BD/day)					Sum (\$ BD) Σ[(1)×(2)]	Priority
	N ₂	N ₄	N ₆	N ₁₀	N ₁₄	N ₂	N ₄	N ₆	N ₁₀	N ₁₄		
1	18	0	0	0	0						18C ₂	14321
...						C ₂	C ₄	C ₆	C ₁₀	C ₁₄
11	12	1	1	1	1						12C ₂ +C ₄ +C ₆ +C ₁₀ +C ₁₄	8234

Alternative No.	(1) Required Truck Quantity					(2) cost ^(*1) (\$ BD/day)					Sum (\$ BD) $\sum[(1)\times(2)]$	Priority
	N ₂	N ₄	N ₆	N ₁₀	N ₁₄	N ₂	N ₄	N ₆	N ₁₀	N ₁₄		
...										
111	8	0	2	2	2						$8C_2+2C_6+2C_{10}+2C_{14}$	1543
...										
1111	4	3	1	1	4						$4C_2+3C_4+C_6+C_{10}+4C_{14}$	12
...										
11111	0	0	0	0	18						$18C_{14}$	432
...										

(*1) cost = purchase price (\$ BD/day) + operating cost (\$ BD/day)

2. Recommendations for Waste Management

2.1. Vehicle Defect

In looking at the defect ratio situation for waste collection equipment in Barbados, there are a total of 66 trucks purchased within the last 10 years where 10 of these are in need of repairs and 21 are damaged beyond operation, making the total of 31 trucks inoperable. This makes the defect ratio for the trucks purchased within 10 years to be 47%, making only 53% operable for waste collection. This is the most serious problem for Barbados's waste management, so the following improvements are recommended:

- There needs to be a special policy for vehicle maintenance and repair.
(easy access to parts, specialization and privatization of vehicle repair services, local residency in Barbados of mechanics from truck manufacturers)
- The required number of trucks needs to be secured.
- A fixed number of trucks must be purchased regularly every year according to a plan.
- The durability life of the trucks should be determined so their usage can be legally stopped after their lifecycles expire, meaning that a phase-out plan is needed to eventually phase out old trucks so that the total number of trucks is not distorted..

Table IV-8 | Defect Ratio of Collection Trucks

Year	1991	1992	1994	1996	1998	1999	2000	2001	2002	2003	Total
In Use						6					6
Repairs	Minor	1				3					4
	Major		1	1	1	1	2	1	1	1	2
Total	1	1	1	1	1	11	1	1	1	2	21

Year	2005	2006	2007	2008	2009	2010	2013	Total	
In Use	15	3	3	3		2	9	35	
Repairs	5	5		2	1		1	2	10
	11	11		2		2	3	3	21
Total	31	3	6	4	2	6	14	66	

2.2. Other Waste Management

The roads in the Barbados city center is arranged in a grid with many one-way streets, and the intersections are roundabouts, making it easy for the garbage trucks to travel. However, the local roads are double lanes only with narrow tree-type layouts, and since many houses are located in dead-end alleys off the main roads, access for the garbage trucks are quite difficult.

As the structural characteristics of the roads determine the waste collection method, the Curb Service and Alley Service currently used in Barbados is considered to be very reasonable. It appears that with the exception of the deficient vehicles, waste management of Barbados is appropriate and well executed, with the following improvements for reference.

Table IV-9 | Comparison of Collection Methods

Indix		Type of Collections				
		Curb	Alley	Set Out-Set Back	Set Out	Back Yard Carry
Resident Cooperation	Bins Brought	○	required	×	×	×
	Empty Bins Taken Back	○	required	×	○	×
Collection Plan with the Residents' Cooperation		○	×	×	○	×
Problems in Landscape Image	Exposure and Leakage	high	high	low	high	low

	Garbage Bins can be seen	○	×	×	○	×
Work is Easy for the Sanitation Workers and Attractive to Scavengers		○	very familiar	×	×	×
Prone to Upsets		○	○	×	○	×
Number of Workers for Efficiency		1~3	1~3	3~7	1~5	3~5
Crew Time		low	low	high	mid	mid
Injury Rate of Worker during Garbage Loading and Unloading		low	low	high	mid	high
Trespassing Complaints		low	low	high	high	high
Cost for Size and Workers and Work Time		low	low	high	mid	mid

Source: Min, et al. (2003). *Waste Disposal Engineering*. Sae-Hwa Publishers

2.2.1. Methods to Improve the MHT Efficiency

The problem with the road structures of Barbados is that they are only double lanes and many dead-ends. In other words, the roads outside the city center is developed in the tree line-type structure and the houses are built parallel along the roads in alleys with dead-ends. The narrow roads are the cause for traffic jams or traffic stops resulting from illegal parking, but on the other hand, the advantage of these roads is that garbage collection can be done from both sides of the road simultaneously.

Currently, the garbage trucks leave the alleys driving backwards due to the dead-ends. The road structure that are the obstacles for waste collection need to be improved with urban planning, but if the dead-ends can be linked together to make a flow traffic road, garbage collection will be easier. The following recommendations can be presented to help with this problem:

- The dead-end streets can be linked together for flow traffic to make it easy for garbage collection (See figure below).
- The residents living on the dead-end streets can bring their garbage voluntarily to the curbs of the main roads for collection.
- The collection trucks can be equipped with small mobile carts and these carts are used for the collection.

Figure IV-3 | Type of Roads

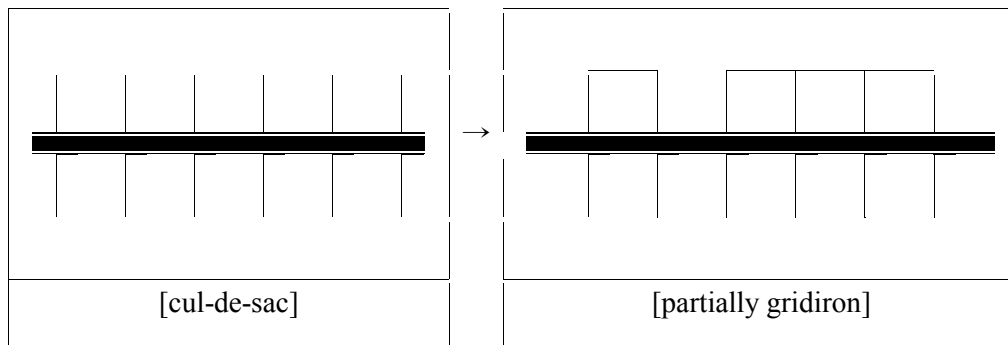

Barbados used the alley and curb collection services. By looking at the Time-Motion Study, the average distance between garbage bins are 38m, so as one of the ways to increase collection efficiency, the distances between the bins can be increased and larger bins can be used.

Figure IV-4 | Suggestions on Improvements in Roads

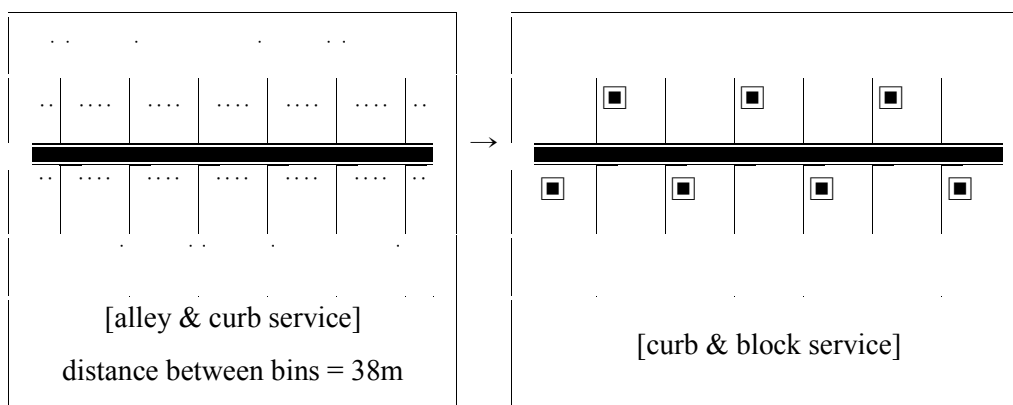

Furthermore, if the collection route is transcribed in the order of the district names, it should be changed into drawings and graphics to make it easy if the loaders change, so the new loaders can memorize the collection routes better. To date, the trucks in Barbados are not equipped with GPS navigators so it seems like the graphic route maps are needed, and when the trucks get equipped with GPS, the collection routes can be displayed on the screens rather than the drawings.

2.2.2. Street Sweeping and Collection Improvement for Narrow Alleys

Currently, street sweeping in Barbados is done by workers with wheeled garbage bins (60~120L), and narrow alleys in the city center are cleaned by small tracker-shaped lorry loaders. In the case of Korea, automatic water-charged vehicles or rear cars are used for street sweeping. The rear cars are more stable compared to the wheeled bins and are easy to use, with the advantage of having the ability to link to bicycles or motorcycles for power.

Figure IV-5 | Equipments for Street Cleaning



[waste bin & lorry loader]

[manual or automatic rear-car]

2.2.3. Systemization and Computerization of Waste Management

It appears that Barbados needs to construct a database on wastes for a more advanced waste management system in the future. In order to construct the database, concerned laws must define what waste is, establish a classification system, and select the classification codes to serve as the basis for the computerization. Afterwards, in order to determine the flow of the waste management system, the waste generation,

transportation, treatment and disposal process need to be computerized. The GPS or RFID can be used partially for this purpose.

- Construction of the database for wastes including the definition, establishment of the waste system and cataloged (Barbados Waste Code, BWC)
- Selection of the Classification Codes
- Computerization of the waste generation, transportation, treatment, and disposal process (computerization, Just-in-Time Record System)
- Regular conduction of statistical surveys on wastes
- Application of the GPS and RFID systems and optimization of routes

2.2.4. Waste Collection

Improvements for the waste collection are as follows:

- Collection bags and bins need to be standardized for easy and efficient collection.
- Existing defect ratio of trucks needs be improved by using various types of collection trucks
- Instead of just using collection region information as route information, the actual road routes used by the collection trucks should be mapped out onto a map for better visual management and checking of route coverage.
- It will be difficult to improve on the current collection routes because the drivers have currently optimized their driving routes to be the most optimum according to the region of their pick-up. Therefore, a GPS-based tracking system is not needed in order to optimize the collection routes.
- Automatic Pipeline Collection System could be considered the in the city center with a high population density in order to improve the waste administration and collection efficiency
- RFID-based tracking system for medical waste could be considered in order to track the whole collection and disposal process of medical waste.

2.2.5. Waste Treatment and Disposal

Improvements for waste treatment and disposal are as follows:

- The re-using and recycling can be optimized with realized policies.
- Automated sorting devices should be installed at the disposal or recycling transshipment depots to efficiently promote the 3Rs.
- Reclaim the methane gas from the existing landfill
- The burying amount can be minimized and the life durability of the landfill can be extended by digging and reorganizing the existing landfill.
- The Waste-to-Energy Policy should be established. In the case for Barbados, it is possible to produce 450 tons/day of 92% combustible MSW and 300 tons/day of RDF (Refuse Derived Fuels). With heat (100 tons/day x 3 incinerators) treatment, it will be possible to produce 10MW of electricity, 25 Gcal/hr of heat, and 10,000 USRT of cold air.

Figure IV-6 | Waste-to-Energy Planst Process

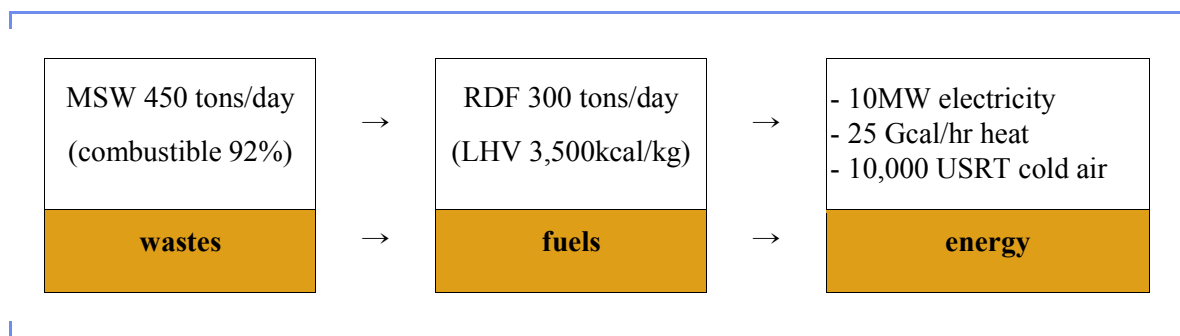

[INTENTIONALLY LEFT BLANK]

3. Economic Feasibility Analysis

3.1. Method of Analysis

In this section, the economic feasibility analysis of the purchasing 15 additional collection trucks is performed using benefit-cost analysis. For this purpose, social benefit and cost of the purchase are estimated, and the economic feasibility is analyzed using Net Present Value (NPV) Method, Economic Internal Return Rate (EIRR), and Benefit/Cost ratio (B/C ratio).

The NPV method is the most widely used technique for economic feasibility analysis. NPV is the sum of present value (PV) cash inflows subtracted by the sum of present value (PV) cash outflows. When the NPV value in the formula is greater than 0, the project is considered as economically feasible. Economic Internal Rate of Return (EIRR) or Internal Rate of Return (IRR) provides a discount rate that equals the sum of present value cash inflows and the sum of present value cash outflows. As a decision criterion to economic feasibility, the EIRR of an investment alternative needs to be greater than social discount rate (social discount rate in the analysis is 12%). Benefit/Cost Ratio shows the ratio of the benefit value of a project relative to its cost value. Since the NPV values are influenced by the volume of investment, B/C ratio is used complementary. When a B/C ratio is larger than 1, the investment alternative is economically feasible.

In addition sensitivity analysis was also performed to analyze the sensitivity of the investment relative to changes in the discount rate, the overall costs, and the overall benefits.

3.2. Assumptions Used for the Analysis

3.2.1. Inflation Rate

We used the average Barbados inflation rate compiled by the IMF from 2012 to 2014 as the inflation rate that will be applied to the estimation of the various future values for the economic feasibility analysis.

Table IV-10 | Inflation Rate of Barbados**(Unit: %)**

Year	2013	2014	2015	3 -Year Average
Inflation Rate	1.823	1.868	1.199	1.630

Source: IMF. (2015). *World Economic Data*. IMF

3.2.2. Period of Analysis

We assumed that 5 collection trucks will be purchased every year for 3 years starting 2016 for a total of 15 new trucks being purchased within the three year period. The reason for the purchase of 15 new trucks is assumed from the recommendations for the number of operational trucks (Section IV.1) where the minimum number of required trucks was calculated as being over 30 trucks and currently there are only about 15 trucks that are operational at this moment for the SSA.

The start of the benefits obtained from the purchasing of new collection trucks was assumed to be from 2017 which is one year after the initial purchase in 2016. The total period for the benefits to arise was assumed to be 10 years after the initial purchase. Salaries for drivers and loaders, cost of gasoline, and maintenance costs for the trucks were assumed to occur every year after the purchase of the new trucks; the total period of the economic feasibility analysis is 13 years from 2016 to 2028.

3.2.3. Discount Rate

We applied 12% as the discount rate for the economic feasibility analysis because 12% is the standard discount rate used by the Export-Import Bank of Korea for all their financial analysis of developing countries.

[INTENTIONALLY LEFT BLANK]

3.3. Cost Analysis

3.3.1. Cost Components

The following are the costs associated with the purchase of new collection trucks:

- Cost of purchasing 15 compactor trucks (5 in 2016, 5 in 2017 and 5 in 2018)
- Operational and maintenance costs per truck

3.3.2. Cost Details

1) The cost of purchasing 15 trucks is

- Year 2016 cost = 5 x USD 250,000 = USD 1,250,000
- Year 2017 cost = 5 x USD 250,000 x inflation = USD 1,270,375
- Year 2018 cost = 5 x USD 250,000 x inflation = USD 1,291,082

2) Cost of operation and maintenance for 13 years is,

- Year 2016 cost = 5 x USD 16,500* x 50% (6 month) = USD 41,250
- Year 2017 cost = 10 x USD 16,500* / year x inflation = USD 167,690
- Year 2018 to Year 2028 cost = 15 x USD 16,500* / year x inflation
- the maintenance cost is based on the data received from the SSA.

3.3.3. Cost Table

The following two Tables show the yearly flow of money needed to cover the costs of purchasing 15 new collection trucks for the next 13 years. The total present value of all the costs is USD 4,430,000.

[INTENTIONALLY LEFT BLANK]

Table IV-11 | Yearly Costs (Future Value)**(Unit: 1,000 USD)**

Costs	2016	2017	2018	2019	2020	2021 ~ 2028	TOTAL
Purchasing of Trucks	1,250	1,270	1,291	-	-	-	3,811
Operation & Maintenance	41	168	256	260	264	1,941	2,929
TOTAL	1,291	1,438	1,547	260	264	1,941	6,740

Table IV-12 | Yearly Costs (Present Value)**(Unit: 1,000 USD)**

Costs	2016	2017	2018	2019	2020	2021 ~ 2028	TOTAL
Purchasing of Trucks	1,116	1,013	919	-	-	-	3,048
Operation & Maintenance	37	134	182	165	150	714	1,382
TOTAL	1,153	1,147	1,201	165	150	714	4,430

3.4. Benefit Analysis

3.4.1. Benefit Components

The following benefits are expected to arise with the purchase of 15 new collection trucks:

- Prevention of decrease in tourism due to environmentally unhealthy and visually unclean situations that might be caused by deficiencies in waste collection from key tourist attractions, and
- Reduction in salary from not working over-time in week-ends

3.4.2. Benefit Details

1) The money savings arising from the prevention of the decrease in tourism can be used as a benefit for purchasing new collection trucks because there was a case in Napoli, Italy where tourism income dropped significantly in 2008 due to problems in waste collection and street cleaning.

The benefit obtained in terms of prevention of the decrease in tourism can be calculated using the following formula:

$$\text{benefit} = (\text{number of new trucks}) \times (\text{average yearly income from tourism}) \times (\text{percentage of decrease in tourism with shortage of one truck}) \times (1 + \text{inflation rate})$$

where

percentage of decrease in tourism with shortage of one truck was assumed to be 0.01% and average yearly income from tourism was assumed to be USD 1.098 Billion (www.wttc.org).

: Year 2017 benefit = 5 x USD 1.098 B x 0.01% = USD 549,000

: Year 2018 benefit = 10 x USD 1.098 B x 0.001% x inflation
= USD 1,116,000

: Year 2019 to Year 2028 benefit = 15 x USD 1.098 B x 0.001% x inflation

2) With more collection trucks, SSA personnel do not have to work on weekends which translates to savings in over-time payments.

The benefit obtained in terms reduction in over-time salary can be calculated using the following formula:

$$\text{benefit} = (\text{number of new trucks}) \times (\text{average daily salary of SSA workers}) \times (\text{number of workers per truck}) \times (\text{number of days of over-time per year}) \times 1.5 \times (1 + \text{inflation rate})$$

where

average daily salary of SSA workers was assumed to be USD 100 per

Table IV-14 | Yearly Benefits (Present Value)

(Unit: 1,000 USD)

Benefits	2017	2018	2019	2020	2021	2022~ 2028	TOTAL
Prevention of Decrease in Tourism	438	794	1,081	981	890	3,788	7,973
Reduction in Salary	86	156	209	190	172	733	1,547
TOTAL	524	950	1,290	1,171	1,062	4,521	9,520

※ discount rate of 12% used

3.5. Results of the Economic Feasibility Analysis

The following Table summarizes the results of the economic feasibility analysis with total benefits being USD 9,520,000 and total costs being USD 4,430,000. The NPV was USD 5,990,000 which is greater than 0, B/C Ratio was 2.15 which is greater than 1.0 and finally the IRR was 43.77% which is greater than 12.00%. Therefore, the results show that it is economically feasible to purchase the 15 new collection trucks.

Table IV-15 | Results of the Economic Feasibility Analysis

(Unit: 1,000 USD)

Analysis	Total Benefit	Total Cost	NPV	B/C	IRR
Feasibility Standard			0	1.0	12.00%
Analysis Results	9,520	4,430	5,090	2.15	43.77%

The following graph shows the plot of the benefits versus costs for this analysis.

Figure IV-7 | Benefit – Cost Graph

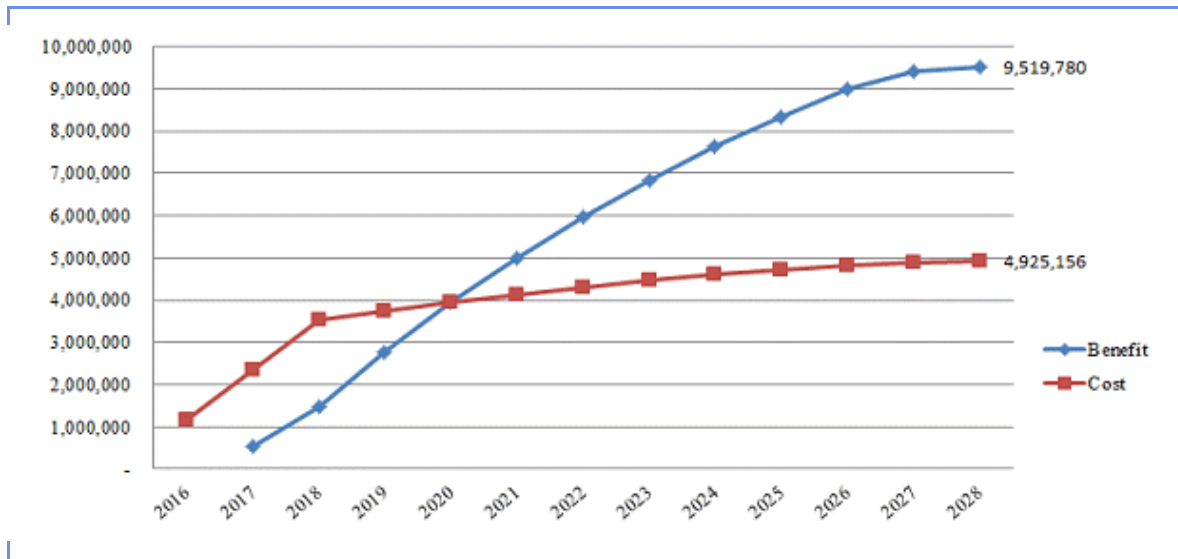

3.6. Sensitivity Analysis

The NPV, B/C Ratio, and IRR were calculated for cases when the overall cost is increased or decreased by 10% and 20% and at the same time the overall benefit is also increased or decreased by 10% and 20%. The Table below shows the results for the different cases of variations.

Table IV-16 | Results of Sensitivity Analysis

(Unit: 1,000 USD)

Variations		NPV	B/C	IRR
Fixed Cost	Fixed Benefit	5,090	2.15	43.77%
Cost Increased by 20%	Fixed Benefit	4,204	1.79	34.65%
Cost Increased by 10%		4,647	1.95	38.84%
Cost Decreased by 10%		5,533	2.39	49.68%
Cost Decreased by 20%		5,976	2.69	56.96%
Fixed Cost		Benefit Increased by 20%	6,994	2.58
	Benefit Increased by 10%	6,042	2.36	49.10%
	Benefit Decreased by 10%	4,138	1.93	38.34%

Variations		NPV	B/C	IRR
	Benefit Decreased by 20%	3,186	1.72	32.78%
Cost Increase by 20%	Benefit Increased by 20%	2,300	1.43	25.03%
Cost Increase by 10%	Benefit Increased by 10%	3,695	1.76	33.80%
Cost Decrease by 10%	Benefit Decreased by 10%	6,485	2.63	55.51%
Cost Decrease by 20%	Benefit Decreased by 20%	7,880	3.22	69.86%

We can determine from the results of the sensitivity analysis that even with the variations in costs and benefits increased or decreased up to 20%, the results of the economic feasibility study stands because the NPV was always greater than 0, B/C Ratio was always greater than 1, and the IRR was always greater than 12.00%.

V. Conclusions and Suggestions

The general assessment of services provided by the Sanitation Services Authority (SSA) of Barbados related to waste collection, disposal and management is that they are currently doing a very good job in all areas of waste collection, disposal and management. SSA's drivers and loaders are very hard working and the managers are dedicated in providing the best possible service to the citizens with the limited resources they have available to them. The collection routes are very efficient and it will be hard to improve on their current collection efficiency.

The areas that need improvements and upgrades are 1) more effective means of maintenance of collection trucks, 2) purchase of additional collection trucks to replace old model trucks that are not functioning to capacity, 3) mapping out actual collection routes on a map, 4) construction of a leachate treatment facility, 5) construction of a waste-to-energy plant to incinerate most of the combustible solid waste prior to burial, 6) increased recycling at the source in order to reduce the amount of waste, 7) designing of a waste code specific to Barbados, 8) development of a waste database to facilitate data management and retrieval, 9) development of a computer program for waste management, 10) research and analysis on setting up intermediary transfer stations throughout the island, 11) standardizing trash bins and garbage bags to facilitate collection, and 12) developing metrics to measure the performance of collection, transportation and disposal of solid waste.

The results of this Consulting Project can be used to better plan for future activities in waste collection, disposal and management in Barbados. Barbados is one of the leading countries in waste collection and management in the Caribbean and hopefully the lessons learned through this project can be transferred to other countries in the Caribbean. Our final proposal is for the Caribbean countries to form an association related to waste management throughout the Caribbean so that countries can share each other's knowledge and expertise as well as collectively strategize concerning the future directions pertaining to waste management in all Caribbean countries.

References

- Ahn, H. (2010). *Improvement Direction of the Waste Management Policy – Construction of an Inter-Governmental Cooperative Governance System*. Korea Local Government Society Bulletin, Vol. 22, No. 4 (Serial #72)
- City of Busan. (2015). *Best Practice: Busan Eco-Friendly Energy Town*. City of Busan
- City of Busan. (2015). *Report on Resource Circulation*. City of Busan
- City of Seoul. (2015). *Report on Resource Circulation*. City of Seoul
- IMF. (2015). *World Economic Data*. IMF
- KMOE. (2013). *2012 Status of Waste Generation and Disposal*. KMOE
- KMOE. (2014). *2013 Status of Waste Generation and Disposal*. KMOE
- KWEA. (2013). *Automatic Pipeline Transport System*. KWEA
- Min, D., Park, J., & Bum, B. (2003). *Waste Disposal Engineering*. Sae-Hwa Publishers
- PAHO. (2003). *Country Analytical Report Barbados*. PAHO
- PMCU. *Description of Private Sector Participation in the Solid Waste Sector in Barbados*.
PMCU
- PMCU. (1994). *Waste Characterisation Study*. PMCU
- PMCU. (2005). *Solid Waste Characterisation Study*. PMCU
- PMCU. (2005). *Review and Evaluation of the Integrated Solid Waste Management Programme for Barbados*. PMCU
- PMCU. (2008). *Final Report, Evaluation of Special Waste Management in Barbados*. PMCU
- PMCU. (2008). *National Profile of Chemicals Management in Barbados*. PMCU
- PMCU. (2013). *Final on Legislation for Solid Waste Management in Barbados*. PMCU
- PMCU. (2014). *Barbados Economic and Social Report*. PMCU
- PMCU. (2014). *Green Economy Scoping Study*. PMCU
- PMCU. (2015). *Waste Characterisation Study for Barbados*. PMCU
- SLC. (2015). *Development of Eco-Friendly Energy Town*. SLC
- SLC. (2015). *Plan for Future Theme Park*. SLC
- SSA. (1987). *Sanitation Service Authority Arrangement of Sections*. SSA
- SSA. (2008). *The Sanitation Service Authority Invitation to Tender for Trucks and Qquipment*.
SSA
- SSA. (2015). *All Vehicles 2015*. SSA
- SSA. (2015). *Daily Tonnage Report 2010, 2012, 2013, 2014*. SSA
- SSA. (2015). *Equipment Acquisitin Modified*. SSA
- Young Geun Chae. (2009). *Problems and Improvements in Waste Management Law*. Association of Environmental Law, Research Paper, Book 31, Number 2
- Yu, K. (2015). *Policy on Waste Management in Seoul*. City of Seoul
- KMOE, KEREC. (2005). *Policy on Extended Producer Responsibility*. KMOE, KEREC

<Webpage Source>

Allbaro System. *Allbaro System*. <https://www.allbaro.or.kr>. Oct. 2015