



SPREP
Secretariat of the Pacific Regional
Environment Programme



This initiative is supported by **PacWastePlus**-a 72 month project funded by the European Union (**EU**) and implemented by the Secretariat of the Pacific Regional Environment Programme (**SPREP**) to **sustainably and cost effectively improve regional management of waste and pollution.**

WASTE TO ENERGY Research Report

November 2021



This *Waste to Energy Research Report*, along with a summary presented in an *Information Booklet*, will provide Pacific Island countries government decision makers, technical specialists, and interested community members, with an overview of options, an analysis of their potential applicability for large population centres, remote islands, and atoll nations.

Disclaimer: This publication was produced with the financial support of the European Union. Its contents are the sole responsibility of SPREP and do not necessarily reflect the views of the European Union. This document has been compiled in good faith, exercising all due care and attention. SPREP does not accept responsibility for inaccurate or incomplete information.

© **Secretariat of the Pacific Regional Environment Programme (SPREP), 2021.** Reproduction for educational or other non-commercial purposes is authorised without prior written permission from the copyright holder provided that the SPREP and the source document are properly acknowledged. Reproduction of this publication for resale or other commercial purposes is prohibited without prior written consent of the copyright owner.



Acknowledgment: This report has been prepared by GHD for Secretariat of the Pacific Regional Environment Programme's PacWaste Programme and may only be used and relied on by SPREP for the purpose agreed between GHD and SPREP. The services undertaken by GHD in connection with preparing this publication were limited to those specifically detailed in the main report and are subject to the scope limitations set out.

SPREP Library Cataloguing-in-Publication

Waste to energy research report. Apia, Samoa:
SPREP, 2021.
86 p. ; 29 cm.

ISBN: 978-982-04-1025-1 (print)
978-982-04-1025-8 (ecopy)

1. Renewable energy resources. 2. Waste recycling.
3. Power resources. I. Pacific Environment Programme (SPREP)
II. Title.

658.2068 2



Secretariat of the Pacific Regional Environment Programme (SPREP)
PO Box 240 Apia, Samoa
www.sprep.org
sprep@sprep.org

Our vision: A resilient Pacific environment sustaining our livelihoods and natural heritage in harmony with our cultures.

As part of SPREP's commitment to the environment, this item is printed on paper made from 100% recycled postconsumer waste.

Contents

Introduction	7
Purpose of this Report	7
Scope and Limitations	7
Assumptions	8
Background	9
Pacific Region	9
Waste Management and Energy in the Pacific Islands	12
Regional Waste Strategy	12
National Waste Legislation and Policies	14
Waste Generation	16
Approaches to Waste Management	18
Energy Demand	19
Applicability of Advanced Waste Technology Options	21
Technology Options	21
Fatal Flaw Methodology	22
Fatal Flaw Analysis Results	24
Thermal Advanced Waste Technology Options	25
Combustion	26
Incineration	28
Pyrolysis	28
Gasification	32
Biological Advanced Waste Technology Options	34
Anaerobic Digestion Process	34
Plug Flow Anaerobic Digestion	40
Household and Community Biodigesters	41
Co-Digestion	43
Mechanical Treatments	44
Technology Choice Considerations	44
Thermal Technologies – Advantages and Disadvantages	44
Biological Technologies – Advantages and Disadvantages	48

Advanced Waste Technology Examples / Case Studies	50
Combustion Examples	50
Pyrolysis Case Studies	52
Gasification Case Studies	54
Anaerobic Digestion Case Studies	56
Community Biodigester Case Studies	58
Feasibility Considerations for the Pacific Islands	61
Fit with Waste Management Hierarchy	61
Availability of Feedstock and Sustaining Supply	62
Scalability	63
Environmental Risks	63
Gender and Social Inclusion	63
Further Constraints	64
PESTLE Analysis	65
Guidance for Decision Making	69
Preliminary Considerations	69
Technical Considerations	70
Enabling Conditions	70
References	72
Appendix A	76

Acronyms

3Rs	Reduce, Reuse, Recycle
ACM	Asbestos Containing Material
AD	Anaerobic Digestion
ADB	Asian Development Bank
ASU	Air Separation Unit
BOOT	Build, Own, Operate, Transfer
BTEX	Benzene, Toluene, Ethylbenzene, and Xylene
C	Carbon
CH₄	Methane
CHP	Combined Heat and Power
CO₂	Carbon Dioxide
COD	Chemical Oxygen Demand
CSTR	Continuous Stirred Tank Reactor
DBOO	Design-Build-Own-Operate
DME	Dimethyl Ether
EEZ	Exclusive Economic Zone
EfW	Energy from Waste
EIA	Environmental Impact Assessment
EOLT	End-of-Life Tyres
FOG	Fats, Oils, and Grease
FSM	Federated States of Micronesia
GHG	Greenhouse Gas
H₂	Hydrogen
H₂S	Hydrogen Sulfide
HCFCs	Hydrochlorofluorocarbons
HRT	Hydraulic Retention Time
JPRISM II	Japanese Technical Cooperation Project for Promotion of Regional Initiative on Solid Waste Management, Phase II
MAP	Microwave-Assisted Pyrolysis
MEA	Multilateral Environmental Agreements
MoU	Memorandum of Understanding
MSW	Municipal Solid Waste
N	Nitrogen
NO_x	Nitrogen Oxides
OEM	Original Equipment Manufacturer
OLR	Organic Loading Rate
PE	Polyethylene
PET	Polyethylene Terephthalate
PESTLE	Political, Environmental, Social, Technological, Legal and Economic
PICs	Pacific Island Countries
PNG	Papua New Guinea
POLP	Pacific Ocean Litter Project
POPs	Persistent Organic Pollutants
PPE	Personal Protective Equipment
ppm	Parts per Million
PPP	Public Private Partnership
PRIF	Pacific Region Infrastructure Facility
RDF	Refuse-Derived Fuel
RE	Renewable Energy
RMI	Republic of the Marshall Islands
RNG	Renewable Natural Gas

SIDS	Small Island Developing States
SOx	Sulfur Oxides
SPREP	Secretariat of the Pacific Regional Environment Programme
SSO	Source Separated Organics
SWM	Solid Waste Management
TS	Total Solids
UASB	Upflow Anaerobic Sludge Blanket
UNEP	United Nations Environment Programme
VFAs	Volatile Fatty Acids
VOCs	Volatile Organic Compounds
VS	Volatile Solids
WTE	Waste to Energy
WWTP	Wastewater Treatment Plant

Glossary of Terms

Air Separation Unit	Unit that separates atmospheric air into its primary components, namely nitrogen and oxygen.
Atmospheric Pressure	Also known as barometric pressure. It is the pressure within the atmosphere of Earth, equal to 1.01325 bar (101,325 Pascals).
Bioavailability	Ability to be absorbed and used.
Biochar	The solid material obtained from the thermochemical conversion of MSW in an oxygen-limited environment.
Bio-oil	Synthetic fuel, the liquid component produced following cooling from the thermochemical conversion of MSW in an oxygen-limited environment.
Biodigester	Device or structure in which the biologic treatment (digestion) of organic waste takes place.
Bottom Ash	Non-combustible residue produced from thermal treatment.
Buffer Tank	Storage tank used to cover peak loads and surges. It provides consistent flow.
By-Product	An incidental or secondary product produced that is not part of the main reaction products.
Calorific Value	Measure of energy contained within a substance. Determined by measuring the heat produced by the complete combustion of a specified quantity of it, for example, units of MJ/kg. Higher calorific value results in more heat and energy produced.
Condenser	Unit used to condense vapour into liquid.
Capex	Capital expenditure.
Cyclone	A device without moving parts which creates a confined vortex from incoming gas, resulting in centrifugal forces driving the suspended particles against the wall of the cylinder for easy collection.
Dewater	The removal of water from solid material or soil through a solid-liquid (two-phase) separation process.
Digestate	The material remaining after anaerobic digestion. Typically, a wet mixture that can be separated into a solid and liquid.
Dimethyl Ether	The simplest ether, with chemical formula: CH_3OCH_3 , it is a colourless gas, and is a useful precursor to other organic compounds such as fuels.
Dioxins	Highly toxic compounds. Dioxins are serious persistent organic environmental pollutants.
Endothermic	An endothermic process or reaction absorbs heat from its surroundings.
Feedstock	Raw material used for processing or manufacturing another product.

Fischer-Tropsch Synthesis	Converts syngas into hydrocarbons.
Flue Gas	The exhaust gas exiting to atmosphere via a flue stack.
Fractionation	Separation process. Separates elements into liquids and gases based on their boiling points.
Gas Turbine	A turbine driven by expanding hot gases, converting the gas to mechanical energy, which can then be converted to electricity via a generator.
Heating Value	Like calorific value, the heating value is the total heat released by a substance during combustion (whereas calorific value is the total energy released).
Hydrogenation	Chemical reaction between a compound and hydrogen (H ₂), usually saturating the compound with hydrogen, for example, to create longer chained hydrocarbons.
Mesophilic	Relating to organisms – mesophiles grow and thrive best in moderate temperature environments.
Municipal Solid Waste	Everyday items that are discarded by the public. Also known as household: “rubbish”, “garbage”, “trash” and so on.
Operating Envelope	Design window of moisture and calorific value.
Opex	Operating expenditure.
Organic Fraction	Organic material within the MSW.
Particulate Matter	Microscopic particles (solid or liquid) suspended in the air. Also called particle pollution.
Pyrolysis Oil	Another term for bio-oil. Bio-oil produced specifically through pyrolysis.
Residence Time	The average time that a unit of feed is within the vessel (e.g., reactor) during a continuous process.
Slag	Usually, a mixture of metal oxides and silicon dioxide (may also contain metal sulphides and elemental metals).
Steam Turbine	Same idea as a gas turbine, but only using steam to convert to mechanical energy.
Synthesis Gas (Syngas)	Fuel gas mixture primarily consisting of hydrogen and carbon monoxide. ‘Dirty’ syngas may require syngas cleaning through scrubbers before being used for fuel upgrading.
Thermophilic	Relating to organisms – thermophiles grow and thrive best in relatively high temperature (higher than mesophiles) environments.

PacWastePlus Programme

The Pacific – European Union (EU) Waste Management Programme, PacWastePlus, is a 72-month programme funded by the EU and implemented by the Secretariat of the Pacific Regional Environment Programme (SPREP) to improve regional management of waste and pollution sustainably and cost-effectively.

About PacWastePlus

The impact of waste and pollution is taking its toll on the health of communities, degrading natural ecosystems, threatening food security, impeding resilience to climate change, and adversely impacting social and economic development of countries in the region. The PacWastePlus programme will generate improved economic, social, health, and environmental benefits by enhancing existing activities and building capacity and sustainability into waste management practices for all participating countries.

Countries participating in the PacWastePlus programme are: *Cook Islands, Democratic Republic of Timor-Leste, Federated States of Micronesia, Fiji, Kiribati, Nauru, Niue, Palau, Papua New Guinea, Republic of Marshall Islands, Samoa, Solomon Islands, Tonga, Tuvalu, Vanuatu.*

KEY OBJECTIVES

Outcomes & Key Result Areas

The overall objective of PacWastePlus is “to generate improved economic, social, health and environmental benefits arising from stronger regional economic integration and the sustainable management of natural resources and the environment”.

The specific objective is “to ensure the safe and sustainable management of waste with due regard for the conservation of biodiversity, health and wellbeing of Pacific Island communities and climate change mitigation and adaptation requirements”.

Key Result Areas

- **Improved data collection, information sharing, and education awareness**
- **Policy & Regulation** - Policies and regulatory frameworks developed and implemented.
- **Best Practices** - Enhanced private sector engagement and infrastructure development implemented
- **Human Capacity** - Enhanced human capacity

Learn more about the PacWastePlus programme by visiting



<https://pacwasteplus.org/>

Introduction

Purpose of this Report

This Research Report, along with a summary presented in an Information Booklet, will provide PIC government decision makers, technical specialists, and interested community members with an overview of options, an analysis of their potential applicability for large population centres, remote islands, and atoll nations. In addition, the report will specify important considerations for PICs, using the PESLTE framework (Political, Environmental, Social, Technological, Legal and Economic) to highlight considerations when assessing suitability of a given technology for a national context.

An Information Booklet providing a summary of this Research Report is also available.

Scope and Limitations

This report: has been prepared by GHD for Secretariat of the Pacific Regional Environment Programme and may only be used and relied on by Secretariat of the Pacific Regional Environment Programme for the purpose agreed between GHD and Secretariat of the Pacific Regional Environment Programme as set out in section 1.1 of this report.

GHD otherwise disclaims responsibility to any person other than Secretariat of the Pacific Regional Environment Programme arising in connection with this report. GHD also excludes implied warranties and conditions, to the extent legally permissible.

The services undertaken by GHD in connection with preparing this report were limited to those specifically detailed in the report and are subject to the scope limitations set out in the report.

The opinions, conclusions and any recommendations in this report are based on conditions encountered and information reviewed at the date of preparation of the report. GHD has no responsibility or obligation to update this report to account for events or changes occurring subsequent to the date that the report was prepared.

The opinions, conclusions and any recommendations in this report are based on assumptions made by GHD described in this report. GHD disclaims liability arising from any of the assumptions being incorrect.

Assumptions

This Research Report, and the accompanying *Waste-to-Energy Information Booklet*, cannot provide a detailed investigation of all technologies on the marketplace. The research acknowledges that technology is developing, and there may be new technologies that provide alternative options, either in the testing phase, or in early development. The options presented in the Report are well known and established as advanced waste technologies at the time of writing this Report.

The waste generation data used in this research was data provided through the 2020 / 2021 PIC waste audits undertaken through SPREP under the PacWastePlus programme, Australian Aid Pacific Ocean Litter Project (POLP), Pacific Region Infrastructure Facility (PRIF) and the United Nations Environment Programme (UNEP). The data was used at a high level to provide context. Any feasibility study will require more detailed data analysis to inform potential technology solutions.

The technologies reviewed use municipal solid waste as a resource to produce an energy output. One exception to this is the inclusion of incineration technologies without a harnessed energy output. The reason for this inclusion is that incineration as an advanced waste technology may be particularly relevant to atoll or remote islands with limited options for landfilling waste.

Technologies that use a feedstock that is not considered as municipal solid waste (e.g., crop and forestry residues, wastewater treatment plant (WWTP) sludge) are also viewed as outside of the scope of this research. Residential or community scale bio-digestion technologies are included due to their potential to utilise household food waste, and their use to date in PICs. Composting systems are not included in the scope. Landfill gas capture and use is also not included in the scope, as despite this being a form of energy derived from waste, this is a component of landfill management as opposed to a system that uses an advanced waste technology as an alternative to landfill.

There are numerous technology vendors that differ in their use of terminology, depending on geographic location and accepted terms and definitions within different regions and different technology providers. To minimise confusion, this Research Report provides a definition for each technology option, but it is noted that terminology may not be consistent on a global basis.

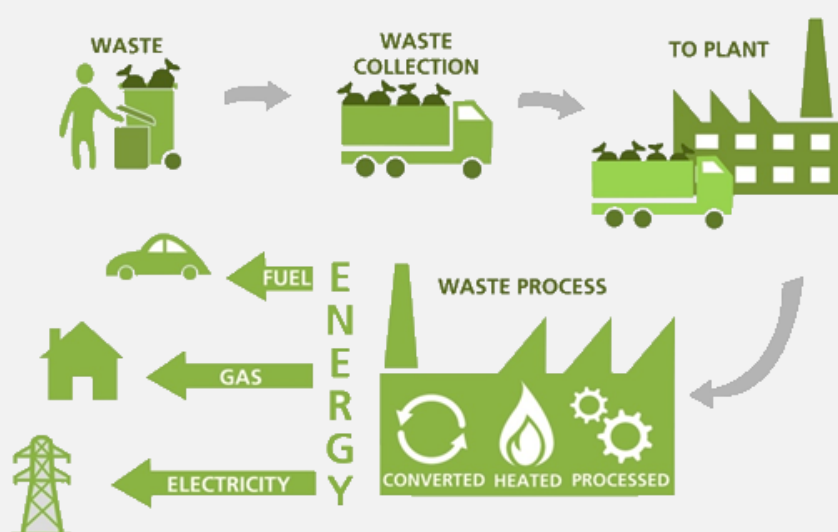

Background

Pacific Region

The Pacific Islands region is in the western, northern, and central Pacific Ocean and consists of 14 independent countries and eight territories delineated into three major ethnic groupings: Melanesia, Micronesia and Polynesia. This research under the PacWastePlus programme, covers member countries including Timor-Leste located on the southernmost edge of the Indonesian archipelago, and classified as part of Southeast Asia. However, demographically, there are several similarities between Timor-Leste and Pacific Island Countries (PICs).

The population across the region, including Papua New Guinea and Timor-Leste is over 12.8 million people, spread over an area equivalent to 15% of the earth’s surface (*World Bank, 2021*). There are hundreds of islands scattered across this unique and diverse region, rich in culture and natural environments, but facing challenges similar to other remote island nations. This may include low and/or spread population base, distance to markets, narrow economies, and growing pressures on limited resources. Pacific Island nations are vulnerable to climate change, many feeling the impacts of rising sea levels and increased natural disasters. External shocks such as COVID-19 can affect economic growth and increase poverty, with impacts expected to continue to pose major challenges for the region into 2022 and beyond.

Figure 1 Map of Pacific Islands Populations and Population Densities

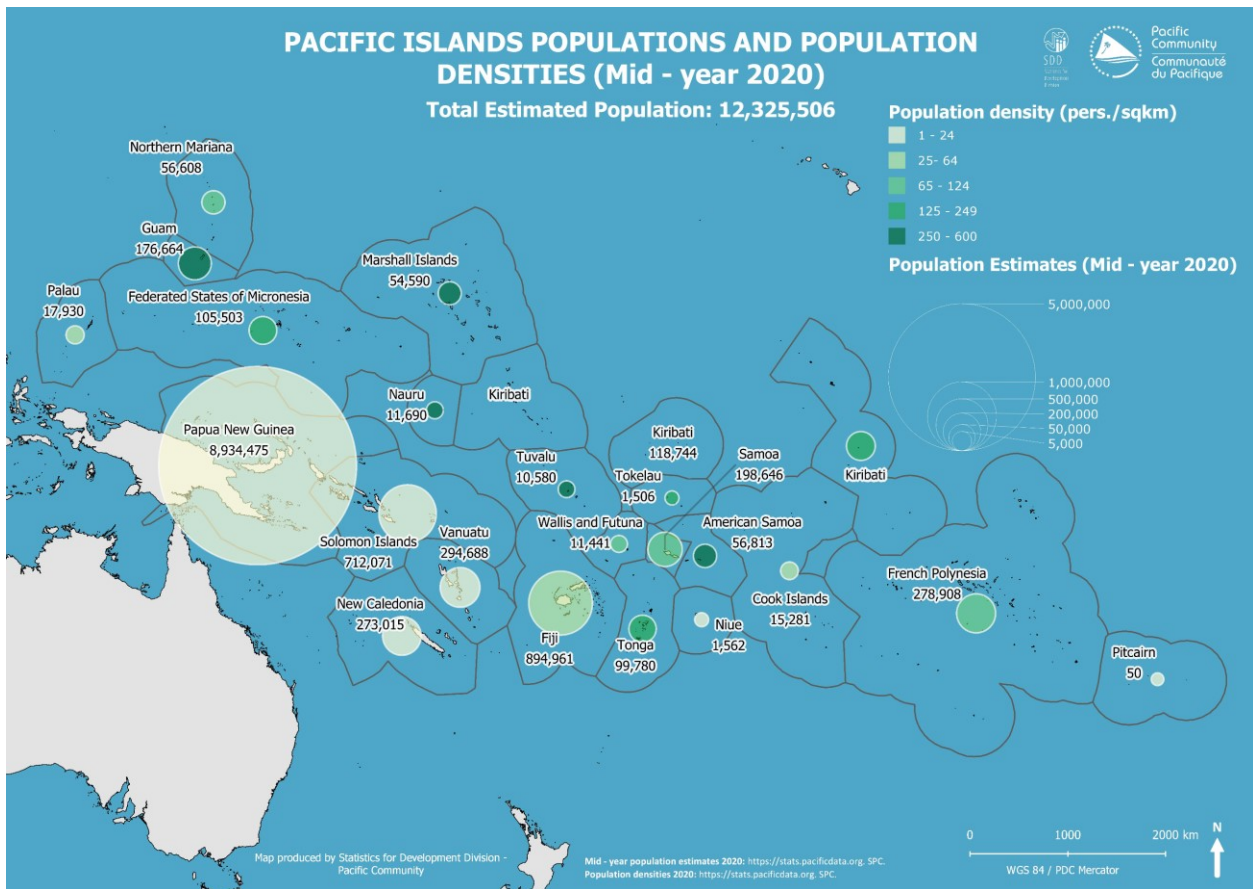

Source: Pacific Community Statistics for Development Division Population Estimates and Projections (2020)

Table 1 General Characteristics of PacWastePlus Participating Countries (2018)

Country/Territory	Land area (km ²)	Last census (year)	Mid-year population estimate	Density (persons /km ²)	Growth rate (%)	Description
Cook Islands	237	2016	15,200	64	0.2	15 islands (13 inhabited). Main island Rarotonga in Southern group, with population of ~13,000. 10 outer island councils. In Northern group, there are five atoll islands and one high island. In Southern group most are high islands.
Federated States of Micronesia	701	2010	105,300	150	0.3	Four states comprised of over 600 islands. Each state has one or more high islands, and numerous atoll islands.
Fiji	18,333	2017	888,400	48	0.4	Fiji has ~110 inhabited islands (out of total of 330). ~87% live on main high islands - Viti Levu and Vanua Levu.
Kiribati	811	2015	120,100	148	2.1	32 atolls and one raised coral island (Banaba). Over 50% of population live on Tarawa.
Nauru	21	2011	11,000	523	1.0	One coral island.
Niue	259	2017	1,520	6	-1.2	One main uplifted coral island.
Palau	444	2014	17,900	40	0.2	~340 islands, with ~two thirds of population based in Koror. Volcanic high and coral islands.
Papua New Guinea	462,840	2020	8,947,000	18	2.2	One high island – eastern part of the island of New Guinea, plus ~600 islands.
Republic of Marshall Islands	181	2011	55,500	307	0.4	Five islands and 29 atolls. Over two-thirds of the residents of the Marshall Islands live in the capital city, Majuro, and the secondary urban centre, Ebeye (located in Kwajalein Atoll).
Samoa	2,934	2016	196,700	67	0.7	Two main populated high islands (Savai'i and Upolu).
Solomon Islands	28,230	2009	682,500	24	2.3	High islands – six major islands and over 900 smaller islands, with some isolated islands and atolls.

Country/Territory	Land area (km ²)	Last census (year)	Mid-year population estimate	Density (persons /km ²)	Growth rate (%)	Description
Timor-Leste	15,007	2015	1,183,643	89	1.9	Timor-Leste is part of Malay Archipelago. Main island is a high mountainous island.
Tonga	749	2016	100,300	134	-0.2	169 islands, 36 inhabited. High islands, coral islands.
Tuvalu	26	2017	10,507	394	0.4	Three reef islands and six atolls.
Vanuatu	12,281	2016	304,500	25	2.5	83 high islands (65 inhabited).

Source: Pacific Community Statistics for Development Division Population Estimates and Projections (2020)



Waste Management and Energy in the Pacific Islands

Regional Waste Strategy

The *Cleaner Pacific 2025: Pacific Regional Waste and Pollution Management Strategy 2016–2025* (Cleaner Pacific 2025) is a comprehensive long-term strategy developed for and in consultation with the Pacific Islands. By addressing waste, chemicals, and pollutants, the Strategy aims to reduce associated threats to sustainable development of the region.

The *Cleaner Pacific 2025's* four strategic goals are:

- Prevention of generation of wastes and pollution;
- Recovery of resources from wastes and pollutants;
- Improved management of residuals; and
- Improved monitoring of the receiving environment.

Within the *Cleaner Pacific 2025*, there is acknowledgement of the growing interest among Pacific Island Countries to explore municipal waste to energy options that reduce the need for landfills and dependence on diesel importation for electricity generation. The promotion of proprietary waste to energy technology by international companies is highlighted in the Strategy as a driver, with concerns that long-term affordability and sustainability are not taken fully into account in these discussions.

The Strategy raises key risks, such as:

- Relatively small municipal waste volumes and the dense, wet quality of most waste streams making feedstocks from PICs generally unsuitable.
- Lack of successful case studies of municipal waste to energy implementation in other SIDS.
- Generation of by-products such as bottom ash, fly ash and flue gas, which may contain particulate matter, heavy metals, dioxins, furans, and sulphur dioxide.
- Capacity to manage hazardous by-products with careful handling, disposal, and environmental monitoring, which are beyond the current capacity of Pacific Island Countries and territories.

The Strategy highlights the case study of Okinawa, Japan, where operating and maintaining waste to energy infrastructure has driven costs up significantly, with technology inappropriate in scale, and impacts on opportunities for waste minimisation. Nonetheless, the Strategy concludes that rigorous investigation of the suitability and risks of waste to energy approaches for PICs is advisable.

There are several Multilateral Environmental Agreements (MEA) that may be relevant when considering advanced waste technologies. These are outlined in **Table 2**, with **Table 3** providing a snapshot of which countries in the region have signed and/or ratified the agreements at a national level.

Table 2 Multilateral Environmental Agreements

Treaty (short name)	Entry into force	Main Provisions
Treaties related to waste and chemicals management		
Basel Convention	24 February 2004	<p>Basel Convention on the Control of Transboundary Movements of Hazardous Wastes and their Disposal</p> <ul style="list-style-type: none"> The overarching objective of the Basel Convention is to protect human health and the environment against the adverse effects of hazardous wastes. Its scope of application covers a wide range of wastes defined as “hazardous waste” based on their origin and/or composition and their characteristics, as well as two types of wastes as “other waste”-household waste incinerator ash.
Minamata Convention on Mercury	Not yet in Force (adopted on 19 January 2013)	<p>Minamata Convention on Mercury</p> <ul style="list-style-type: none"> A global treaty to protect human health and the environment from the adverse effects of mercury. Highlights of the convention include a ban on new mercury mines, the phase-out of existing ones, control measures on air emissions, and the international regulation of the informal sector for artisanal and small-scale gold mining.
Montreal Protocol	1 January 1989	<p>Montreal Protocol on Substances that Deplete the Ozone Layer</p> <ul style="list-style-type: none"> Protects the ozone layer by phasing out the production and consumption of a number of substances responsible for ozone depletion. The current emphasis (for Pacific Parties) is to phase out the import and use of HCFCs, which are primarily used in refrigeration and air-conditioning servicing.
Rotterdam Convention (2004)	24 February 2004	<p>Rotterdam Convention on the Prior Informed Consent Procedure</p> <ul style="list-style-type: none"> Provides an early warning system on hazardous chemicals, and enables monitoring and controlling trade of chemicals, giving Parties power to decide which they wish to import and exclude those they cannot manage safely. There are 47 chemicals, out of which 33 are pesticides, and four are severely restricted hazardous substances.
Stockholm Convention (2001)	17 May 2004	<p>Stockholm Convention</p> <ul style="list-style-type: none"> Aims to protect human health and environment from the adverse effects of 23 identified toxic chemicals (POPs) that, when released, persist in the environment, and can lead to serious health effects including certain cancers, birth defects, neurological effects, and greater susceptibility to disease.
Waigani Convention	21 October 2001	<p>The Waigani Convention to Ban the importation into Forum Island countries of Hazardous and Radioactive Wastes and to Control the Transboundary Movement of Hazardous Wastes within the South Pacific Region</p> <ul style="list-style-type: none"> Constitutes the regional implementation of the Basel Convention in the Pacific, however, coverage extends to radioactive waste, and to the EEZ (20 nautical miles) of Parties.

Table 3 PacWastePlus Countries – Parties to Multilateral Environment Agreements

Country	Waigani	Basel	Rotterdam	Stockholm
Cook Islands	X	X	X	X
FSM	X	X		X
Fiji	X			X
Kiribati	X	X		X
Nauru	S	X		X
Niue	X			X

Country	Waigani	Basel	Rotterdam	Stockholm
Palau	S	X		X
PNG	X	X		X
Republic of Marshall Islands		X	X	X
Samoa	X	X	X	X
Solomon Islands	X			X
Timor-Leste				
Tonga	X	X	X	X
Tuvalu	X			X
Vanuatu	X	X	X	X

X: Ratified or accepted; S: Signed but not ratified (SPREP 2021)

National Waste Legislation and Policies

The following table provides an overview of each PacWastePlus participating country and the results of a recent assessment in relation to existing waste management legislation. More comprehensive details are available in each country's Legislative Assessment Report (available on SPREP website), with

Table 4 providing a snapshot of the current legislative context, as well as noting the most recent developments in the waste policy space.

Table 4 Snapshot of Waste Legislation Assessment and Key SWM Policies and Initiatives

Country	Waste Management Legislative Assessment	Key Policies and Initiatives
Cook Islands	Relevance: Medium-High Cohesiveness: Medium Effectiveness: Medium Efficiency: Medium Impact: Medium-High	<ul style="list-style-type: none"> MoU with SPREP to progress implementation of Sustainable Financing for Waste Management – Advanced Recovery Fee and Deposit System. Policy for a single-use plastic free Cook Islands. Policy vision is an informed and proactive community taking responsibility for sustainable SWM and aspiring towards Zero Waste Cook Islands.
Fiji	Assessment not yet finalised / published.	<ul style="list-style-type: none"> National Waste Strategy 2011-2014. Clean Environment Policy. National Oceans Policy 2020-2030.
FSM	Relevance: Medium-High Cohesiveness: Medium-High Effectiveness: Medium Efficiency: Low-Medium Impact: Medium	<ul style="list-style-type: none"> FSM National Waste Strategy 2015-2020. Yap State SWM Strategy 2018-2027 (Action Plan 2018-2022). Kosrae, Pohnpei, and Yap have a Container Deposit System for the collection of PET bottles and aluminum cans. Currently working with PacWastePlus to improve organic waste management in Chuuk and Yap.
Kiribati	Relevance: Medium Cohesiveness: Medium Effectiveness: Medium-High Efficiency: Medium Impact: Medium-High	<ul style="list-style-type: none"> Kiribati Waste Management and Resource Recovery Strategy 2020–2030 recently adopted, with a broad range of strategic goals to achieve a clean and beautiful Kiribati. Kiribati has a container deposit system for the return of glass and plastic bottles (PET).
Nauru	Relevance: Low Cohesiveness: Low Effectiveness: Low	<ul style="list-style-type: none"> Integrated Chemical and Waste Management Policy being developed with support from UNEP. Nauru Solid Waste Management Strategy 2011-2020.

Country	Waste Management Legislative Assessment	Key Policies and Initiatives
	Efficiency: Low Impact: Medium	
Niue	Relevance: Medium-High Cohesiveness: Medium-High Effectiveness: Medium Efficiency: Medium Impact: Medium-High	<ul style="list-style-type: none"> National Integrated Waste Management Strategy 2010-2015. Currently working with PacWastePlus to implement an effective sustainable financing system for recoverable and recyclable items and e-waste management.
Palau	Relevance: High Cohesiveness: High Effectiveness: High Efficiency: High Impact: Medium-High	<ul style="list-style-type: none"> National Solid Waste Management Strategy – the Roadmap Towards a Clean and Safe Palau 2017-2026. Working with PacWastePlus to implement an effective management programme for End-of-Life Tyres (EOLT).
Papua New Guinea	Relevance: Medium Cohesiveness: Medium-High Effectiveness: Medium Efficiency: Low-Medium Impact: Medium	<ul style="list-style-type: none"> Working with PacWastePlus to provide a holistic approach to hazardous waste management through the development of national strategies and regulations and build capacity and community awareness.
RMI	Relevance: High Cohesiveness: Medium Effectiveness: Medium-High Efficiency: Medium-High Impact: Medium-High	<ul style="list-style-type: none"> Solid Waste Management Plan for Majuro. ADB funded programme to install advanced waste technology for residual waste management. Working with PacWastePlus to introduce a programme to divert the largest two components of waste - organics (17%) and paper/cardboard (22%) - from landfill and instead be processed and transported to an existing organic facility.
Samoa	Relevance: High Cohesiveness: High Effectiveness: Medium-High Efficiency: Medium-High Impact: Medium-High	<ul style="list-style-type: none"> National Waste Strategy 2019-2023, with the vision of a clean and healthy Samoa. Working with PacWastePlus to introduce an E-Waste take back system in the country for the collection, safe dismantling, export, and recycling of end-of-life electronic products.
Solomon Islands	Relevance: Medium Cohesiveness: Medium Effectiveness: Medium-High Efficiency: Medium Impact: Medium-High	<ul style="list-style-type: none"> National Waste Management and Pollution Control Strategy 2016-2026. Working with PacWastePlus to introduce new systems to improve management of organic waste and recyclables.
Timor-Leste	Relevance: Medium-High Cohesiveness: Medium Effectiveness: Medium Efficiency: Low-Medium Impact: Low-Medium	<ul style="list-style-type: none"> A ban on single use plastic bags came into effect on 23 February 2021. Working with PacWastePlus to improve management of healthcare wastes through creation of a national policy, capacity building for healthcare waste handling and disposal, support for waste transport infrastructure, provision of Personal Protective Equipment (PPE), and the clean-up of soils/debris from the legacy hospital disposal site.
Tonga	Relevance: High Cohesiveness: Medium Effectiveness: Medium-High Efficiency: Medium Impact: Low-Medium	<ul style="list-style-type: none"> ADB funding of further improvements to landfill and waste collection infrastructure and services. Working with JPRISM II for improved waste management in outer islands. Working with PacWastePlus to improve management of asbestos and asbestos containing material (ACM) through development of national legislation to ban the importation and use of asbestos, raise public awareness of asbestos and safety, update Code of Practise to guide the management

Country	Waste Management Legislative Assessment	Key Policies and Initiatives
		and handling of asbestos, provide training on asbestos abatement work (handling and disposal), and abatement of ACM from a few selected buildings in Tongatapu.
Tuvalu	Relevance: Medium-High Cohesiveness: Medium-High Effectiveness: Medium-High Efficiency: Medium Impact: Medium	<ul style="list-style-type: none"> • The 'Tuvalu Integrated Waste Policy and Action Plan 2017-2026' is the main national policy framework with the vision of having “A Cleaner and Healthier Tuvalu for today and future generations”. • Working with PacWastePlus to deliver improvements for waste management in outer islands. Also, development of a Strategic Plan for asbestos management and expanding the Tuvalu Waste Levy to enable outer islands to gain benefit from this sustainable finance waste management system • Tuvalu has a container deposit system
Vanuatu	Relevance: Medium-High Cohesiveness: Medium-High Effectiveness: Medium Efficiency: Medium-High Impact: Medium	<ul style="list-style-type: none"> • National Waste Management and Pollution Control Strategy and Implementation Plan 2016-2020 • Working with PacWastePlus and J-PRISM II to develop and implement a suitable sustainable financing system (Product Stewardship Scheme) to facilitate collection and recycling of recoverable items

Waste Generation

With final reports on waste composition data not publicly available at the time of this review, the figures included represent broad data from a range of sources. As such, the data are provided for indicative purposes based on preliminary data.

This data will require refining as the waste audit data is verified, but there will also need to be improved granularity on the location of waste generation sources within each country to provide information on how disparate or concentrated waste sources are. The estimated waste tonnages per annum are broadly indicative, with accuracy varied depending on data source, and methodology.



Table 5 Estimated Waste Generation Rates for PacWastePlus Countries

Country	Population	Estimated Waste (tonnes / annum)	Comments
Cook Islands	15,200	4,200	Data based on waste being disposed at Rarotonga Landfill (Palmer, 2012).
Kiribati	115,847	16,000	Estimated organic fraction is over 60%
Nauru	11,000	15,700	Based on Draft findings from landfill audits conducted in 2020 (waste audit – unpublished draft report).
Niue	1,520	1,100	Based on Draft findings from landfill audit conducted in Makato and Vaiea landfills (waste audit – unpublished draft report).
Palau	17,900 (but with large visitor numbers in addition to population)	12,410	Based on figures in National Strategy – waste audit data for Koror and Babeldaob.
Papua New Guinea	8,947,000	1,730,800	Based on total estimated waste generation rate (across low, medium and high-income households) of 0.53 kg/day (SPREP 2021 – unpublished draft report).
RMI		8,500	Estimate for Majuro only (main population centre).
Samoa	196,700	24,195	Estimate based on .337 kg/person/day for Upolou (SPREP 2021 – unpublished draft report).
Solomon Islands	682,500	40,250	Estimate based on combined rural and urban data, noting that ~75% is generated in rural areas (Wander et al 2018).
Timor-Leste	1,200,000	184,000	Very broad estimate, based on figure of .27 - .57 kg/person/day, depending on location of audit and rural vs urban populations (SPREP 2021 – unpublished draft report). Estimated waste generation based on average of .42 kg/person/day.
Tonga	100,300	17,200	Based on estimate of .47 kg/person/day (PRIF 2018).
Tuvalu	10,507	1,060	Estimate based on audit figures for September 2019 – household and other sources of waste (Sagapolutele et al, 2019).
Vanuatu	304,500	26,500	Based on audit data for waste disposed of at two main landfill facilities and estimates of generation rates for outer islands.

Approaches to Waste Management

Globally, the major drivers for countries to consider advanced waste technologies are summarised in **Figure 2**. Whilst landfills generally remain as a lower cost option, other drivers in policy provide the incentive for change. Many countries introduce levies on landfills to change the economic balance and incentivise alternative approaches.

Figure 2 Global Drivers for Adopting Advanced Waste Technologies

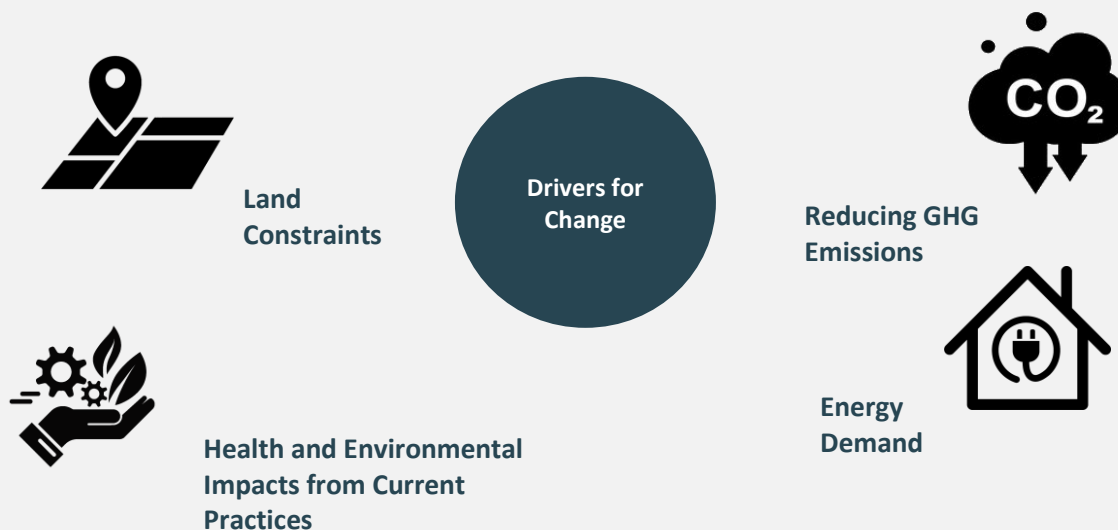

In the participating PacWastePlus countries, there are a range of challenges and constraints applicable to waste management, including:

- Relatively small population sizes coupled with high population density in urban centres
- Unplanned urban sprawl
- Fluctuating visitor arrival numbers contributing to waste generation
- Lack of access to reliable and efficient waste collection services
- Lack of land availability for landfill expansion and development of new disposal sites
- Changing lifestyle and consumer choices leading to increased volumes of waste generation
- Increase in low-cost short life cycle products to provide affordable goods, but with increasing waste generation
- Distance to market for recycling commodities and lack of economy of scale
- Low awareness or engagement in improved waste management
- Limited willingness to pay for waste services and infrastructure
- High-wear coastal environments combined with lack of funding or capacity for vehicle and equipment maintenance
- Insufficient government priority and political support for action
- Increasing presence of plastic marine debris
- Limited energy security due to reliance on imported fuels

Each country responds to these challenges differently, but with an increasing donor, Decision-maker, and community focus on improved waste management, there have been significant improvements in waste management in the Pacific over the last decade. This includes improving the legislative and policy framework through to initiatives on the ground such as container deposit schemes or improved infrastructure for waste collection, recycling, and disposal.

All final disposal currently occurs either through:

- Sanitary disposal in engineered landfill site (e.g., Tonga and Fiji)
- Disposal in semi-aerobic landfill site (e.g., Samoa and Vava'u in Tonga)
- Disposal in managed landfill site (e.g., Kiribati)
- Unregulated dumping (to marine and land environments), particularly in remote island locations
- Unregulated burning of waste
- Increased natural disasters creating more debris and waste

In the region, there has been a move towards sanitary landfills, complemented by waste minimisation efforts such as recycling and composting. Given the constraints, particularly the identification of suitable sites for landfill operations, many countries are seeking alternative solutions, and in many instances have been approached by companies offering advanced waste technology solutions such as anaerobic digestion, energy from waste and other waste to fuel technologies to dramatically reduce the volume of waste and offset the import of fossil fuels and fertilisers. A shift in focus, from the problem of waste to a materials management perspective, has the potential to bring environmental and economic dividends, with advanced waste technologies playing an anchoring role within an entire waste management system that has been carefully planned with trouble shooting of all potential problems and impacts (*Howell 2015*).

Any appraisal of technologies must be informed by locally specific feasibility work, so that any technologies are appropriate to local opportunities and constraints. Experience elsewhere demonstrates that thorough planning and appraisal without a bias towards a particular technology or company are fundamental to sound decision making.

Energy Demand

Energy demand between 2005 and 2030 was projected at an average of 7% per annum, with an increase in generation capacity predicted at 6.4% per annum (*ADB, 2013*). Energy is recognised as a pillar of economic development and security in the Pacific, with most countries having an energy policy or roadmap in place. Policy targets for renewable energy are ambitious, with 13 out of 14 Pacific Small Island Developing States (SIDS) committing to renewable targets (*IRENA 2021*). As outlined in Table 6, the Pacific Islands have led with ambitious targets, but face numerous challenges to achieve these targets. However, with significant focus, the generation from renewable sources will increase. ADB funded renewable energy infrastructure projects are underway in 13 Pacific Islands and at a regional level, boosting the sector (*SPREP 2020*).

Nonetheless, challenges remain. Generating 100% of electricity requirements is costly in countries without low-cost renewable energy resources. Solar and wind power is available, but costly given the low wind speeds and the need to disaster proof infrastructure (*Dornan 2012*). Countries fortunate to have hydropower, geo-thermal or biomass supplies are in a better position, but diversification of electricity sources is a key pillar of energy security (*Dornan 2012*).

Table 6 Renewable Energy Targets and Actual % of Generation

Country	Policy Target for Renewable Energy	Actual % of Electricity from Renewables (2018 or most recent data)
Cook Islands	100% by 2020	26%
Democratic Republic of Timor-Leste	50% by 2030 and 100% by 2050	18%
Federated States of Micronesia	30% by 2020	5%
Fiji	100% by 2036	60%
Kiribati	45% reduction in fossil-fuel energy generation by 2025	~2% with expected 9% on RE project completion
Nauru	50% by 2020	2%
Niue	80% by 2025	14%
Palau	45% by 2025	2%
Papua New Guinea	50% GHG reduction by 2030	62%
Republic of Marshall Islands	20% by 2020 100% by 2050	~2% with expected 9% on RE project completion
Samoa	100% by 2017	42%
Solomon Islands	20% by 2020	6%
Tonga	50% by 2020 70% by 2030	10%
Tuvalu	100% by 2020	23%
Vanuatu	100% by 2030	22%

Whilst generating energy from waste provides tangible benefits in the renewable energy sector, it is advisable to always consider the technology in the context of waste management first, rather than from an energy production lens. This important messaging is often lost when considering WTE technologies and the implementation of a WTE facility. While the energy products provide value, the primary function of WTE is that it contributes to sustainable waste management.

WTE needs to be considered as only one part of a comprehensive waste management plan. Projects should begin with waste minimisation as a public policy, followed by waste recycling and WTE incineration, and ending with the remaining ash delivered to local landfills (*KPMG 2021*).

While WTE systems provide a highly valued source of renewable energy, perhaps the greatest benefit of WTE comes from the waste perspective, with its ability to convert waste into ash, reducing the volume of waste entering landfills by up to 85%, and reducing methane emissions from the decomposition of organic waste in landfills (*Stringfellow 2014*). In locations where landfilling is becoming an increasingly non-viable option due to lack of available land, WTE technologies are a viable alternative.

Applicability of Advanced Waste Technology Options

Technology Options

In the challenging context of managing waste in the Pacific Island and Timor-Leste regions, traditional landfill infrastructure may not always be the best option for residual waste. Particularly in countries containing atoll islands, or countries with limited land availability, there is an appetite to explore alternative options. Given the potential to generate energy from waste, thus using it as a resource, converting waste to energy is often promoted as an ideal solution. Converting waste into energy is viewed in many jurisdictions as a critical component of a circular economy (after waste reduction, reuse, and recycling), reducing CO₂ emissions and utilising resources to create a more sustainable form of energy.

WTE technologies are rapidly developing, with a wide array of technology options available, varying in approach, scale, complexity, and outcomes. However, there are several technologies that are inappropriate for the Pacific Island and Timor-Leste context, given their feedstock requirements, scale, complexity or operating requirements. This section of the Research Report provides a high-level overview of each type of advanced waste technology and applies a fatal flaw analysis, narrowing down the options to those that may be suitable for further investigation. This section provides a snapshot, acknowledging that technology options change over time as research and development progresses, and case studies on the ground inform ongoing advancements.

The conversion of waste into energy generally occurs through two major processes, (i) thermal technologies, (ii) biological technologies, and (iii) mechanical technologies which is often a pre-treatment step to another treatment process, but it can also produce a refuse-derived fuel (RDF) in its own right, and as such has been included as a stand-alone category.

Figure 3 Overview of Waste to Energy Technology Options

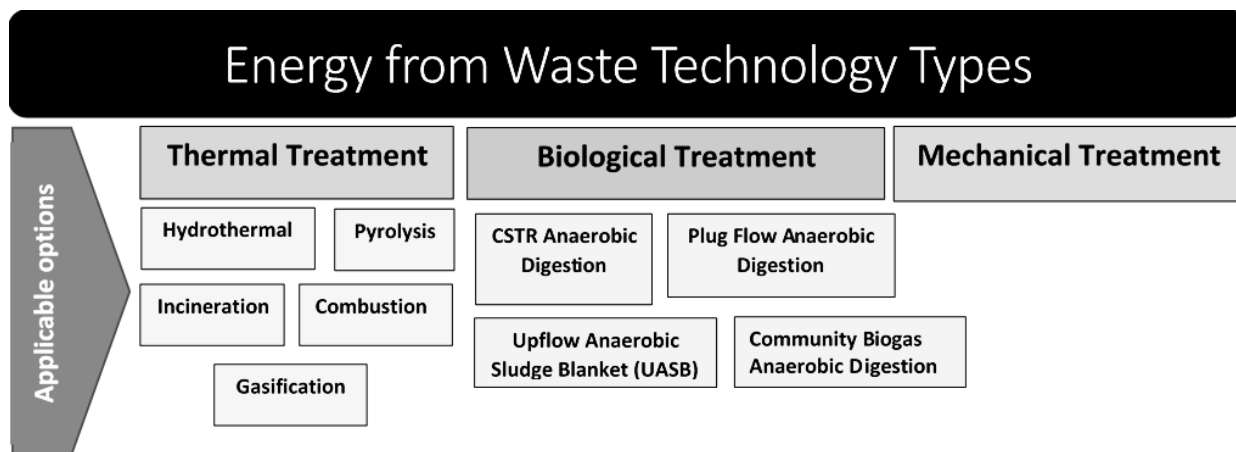

A list of advanced waste technologies that will be explored in this report, along with an overview of their respective energy outputs, are outlined in **Table 7**.

Table 7 Advanced WTE Technologies for Waste Treatment

Technology	Energy Outputs
Thermal Technologies	
Hydrothermal treatment (including carbonisation, liquefaction, and supercritical water gasification)	Solid fuel and liquid fuel
Pyrolysis (including slow, fast, microwave-assisted, and ultrafast)	Biochar, pyrolysis oil and syngas
Gasification (including direct, indirect, and plasma)	Bio-oil and Syngas
Combustion (waste to energy)	Power and heat
Incineration (waste destruction)	Heat
Biological Technologies	
Plug flow anaerobic digestion	Biogas
Continuously stirred tank reactor (CSTR) anaerobic digestion	Biogas
Upflow anaerobic sludge blanket digestion (UASB)	Biogas
Anaerobic co-digestion	Biogas
Household or community anaerobic digestion	Biogas
Mechanical Technologies	
Pulverisation and drying	Refuse-derived fuel / solid recovered fuel

Fatal Flaw Methodology

There are a significant number of advanced waste technologies available on the market, as well as in the development stages. However, many of these technologies are not feasible for use in the Pacific Islands currently.

Several country constraints on adoption of these technologies include:

- Waste feedstock availability (quantity and type)
- Population (and waste) distribution across large areas or remote island locations
- Composition of the waste (mixed, high organic content and high moisture content)
- Collection systems and capacity for waste segregation
- Land availability
- Energy and water availability
- Technological and engineering capacity for ongoing operations and maintenance
- Fragile environment in island locations, with the need to protect local eco-systems and water resources
- Limited financial resources or willingness to pay for higher waste costs
- Geographic isolation from technology providers and maintenance services

Considering these constraints, it is logical to remove unfeasible technology options from the more detailed analysis. If a technology has virtually no possibility of viability in a PIC context, this was removed from further consideration.

As such, the following fatal flaws were developed as a decision-making tool, as outlined in **Table 8**. The considerations were prepared and agreed on with SPREP as part of the methodology for the research.

Table 8 Fatal Flaw Considerations

	Factors	Fatal Flaw when:
Technological	Technology maturity	Not commercially proven for MSW
	Scale of technology and ease of transportation	Difficult to transport and set up in PICs and remote locations
	Minimum feedstock requirements	Requires a vast amount of feedstock beyond PICs waste generation
	Operational requirements such as energy and water	High energy and water requirements, outweighing the technology benefit
	Technology lifetime, particularly suitability for harsh coastal operating conditions	Significant limitation on technology lifetime (<20 years)
Social	Safety	Poses safety issues to the immediate surroundings
	Potential for gender or social inequity	Access to benefits of technology not equitable, or impact burden inequitable
Environmental	Human health	Poses risk to human health
	Pollution (air, water, land)	Significant pollution arising from the technology
	Land requirement	Large footprint / land required

In addition, both capital and operations / maintenance costs bear consideration. Whilst costs are a critical component of feasibility work, they were not included as a fatal flaw as capital costs may be covered through donor grants or loans, and if they meet donor feasibility requirements such as internal rate of return, capital costs may not be a core consideration for countries. Operating costs will clearly be a critical issue but will be considered as a part of more detailed feasibility work given the highly varied input costs based on scale, collection systems, population dispersal and waste composition.

The complexity of the technology is also a key feasibility consideration, with capacity for operations and maintenance a key risk. However, this issue applies to nearly all advanced waste technologies, and is best addressed through risk mitigation tools such as long-term contracts for build, own, operate, transfer (BOOT) of technologies, which can also include long-term maintenance contracts with technology providers. As such, it is recognised as a critical issue, but not a fatal flaw.

The eleven technologies outlined in **Table 7** were analysed to determine whether they contained any fatal flaws, rendering them as a non-viable option for use in PICs.

The research team in collaboration with representatives from the PacWastePlus programme undertook the evaluation. The research team presented findings, with the group reviewing each option in relation to the technological, social, and environmental aspects of each technology. A score was applied using a “traffic light” categorisation system, as shown in **Figure 5**. Green indicates the technology is not affected by the fatal flaw, while red signals the fatal flaw applies. Yellow indicates the fatal flaw possibly applies, demonstrating that it may be an issue, but is not clearly able to signal a “no-go” decision at this stage of the analysis.

The scoring system applies five points to any red classification, one point to yellow classifications, and no points for green classifications. Technologies with a total score of five or higher suggests they are not suitable for the Pacific Islands and Timor-Leste and thus deemed as fatally flawed. This resulted in no further analysis being undertaken within this research.

Fatal Flaw Analysis Results

Figure 4 Results of Fatal Flaw Analysis

			WTE Technologies											
			Hydrothermal	Pyrolysis	Gasification	Combustion	Incineration	Plug Flow AD	CSTR	UASB	Co-Digestion	Household or Community AD	Mechanical	
			W1	W2	W3	W4	W5	W6	W7	W8	W9	W10	W11	
Technological	Factors	Fatal Flaw when:	No = 0											
	Technology maturity	Not commercially proven for MSW		5	0	0	0	0	1	5	5	1	1	
	Scale of technology and ease of transportation	Difficult to transport and set up in PICs and remote locations			0	0	0	0	0			0	0	
	Minimum feedstock requirements	Requires a vast amount of feedstock beyond PICs waste generation		5	1	1	0	0	0	5	5	0	0	
	Operational requirements such as energy and water	High energy and water requirement, outweighing the technology benefit		5	0	0	1	5	0			0	0	
Social	Technology lifetime	Significant limitation on technology lifetime (<20 years)	Maybe = 1		1	1	1	0	0			0	1	
	Safety	Poses safety issues to the immediate surroundings			1	1	1	1	1			1	1	
	Potential for gender or social inequity	Access to benefits of technology not equitable, or impact burden inequitable			0	0	0	0	0			0	0	
Environmental	Human health	Poses risk to human health	Yes = 5		1	1	1	1	0			0	0	
	Pollution (air, water, land)	Significant pollution arising from the technology			0	0	0	1	0			0	0	5
	Land requirement	Large footprint / land required			0	0	0	0	0			0	0	

Following the fatal flaw analysis, some technologies are viewed as unviable, and have been ruled out of further discussions, as per **Figure 5**. Further technical details of these technologies are available in **Appendix A**.

Note that gasification as a broad technology grouping it is viewed as potentially viable. However, indirect gasification and plasma gasification are viewed as fatally flawed due to large minimum feedstock requirements and lack of technological maturity.

Figure 5 Elimination of Technologies Following Fatal Flaw Analysis

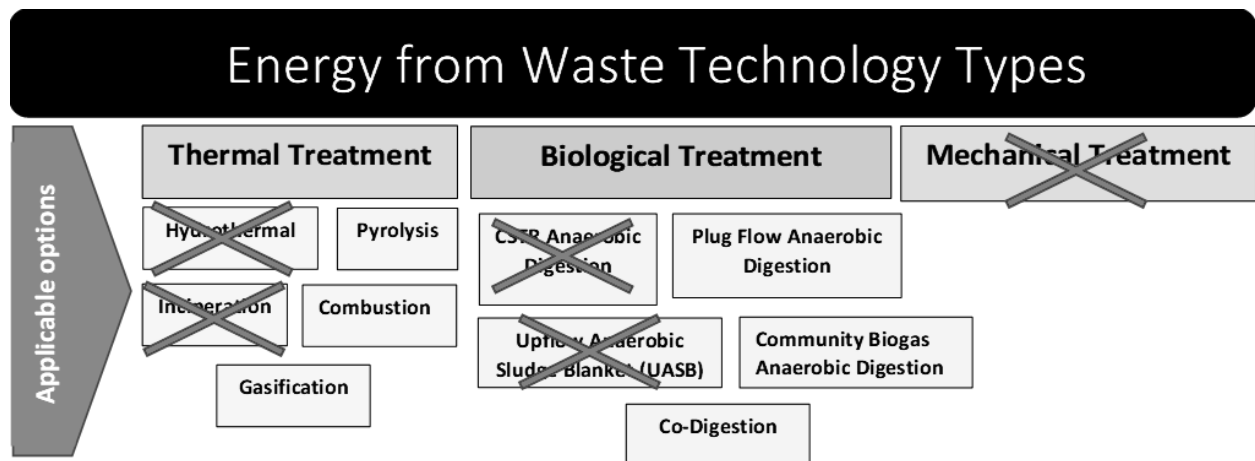

Thermal Advanced Waste Technology Options

Globally, there are over 1,700 thermal WTE plants worldwide, with over 80% located in developed countries, led by Germany, France, Japan, and the United States (UNEP 2019). Growing attention to the opportunities from these technologies can be seen globally and in developing countries, with more than 200 plants currently under construction with commissioning dates between 2020 and 2023. China, Thailand, the Philippines, Indonesia, and Myanmar are examples of countries moving towards this technology, providing the opportunity to review case studies on the ground, and the applicability of these technologies in the Pacific context.

The main technologies involved in thermal treatment include hydrothermal, pyrolysis, gasification, combustion, and incineration processes. All these technologies utilise heat to reduce waste into stable end-products, producing differing types and quality of energy (heat energy, solid biochar, bio-oil, syngas) depending on the operating parameters including oxygen levels, temperature, and pressure. For most of these thermal processes, a dry waste feedstock with low moisture content and high non-biodegradable organic matter are best suited to achieve efficient high yield results.

Following the fatal flaw analysis, hydrothermal and incineration processes have been removed from further consideration. However, further technical details of these options are provided in **Appendix A**.

Combustion

There are many definitions for both combustion and incineration, and these terms are sometimes used interchangeably. Therefore, for the purpose of this report, combustion has been defined as any chemical reaction with a feedstock which produces heat as energy. Alternatively, incineration has been defined as the destruction of feedstock via burning where heat and energy are not intended to be harnessed for use.

The combustion process utilised in a WTE plant moves waste into a furnace where it is combusted at high temperatures to recover energy and sometimes heat. The main feature of WTE is an ability to reduce most wastes by up to 85% of their original volume. It also has strong benefits for clinical and hazardous wastes where toxins and pathogens can be destroyed by high temperatures. Different variations are traditionally classified according to the method in which waste is moved through the furnace. Rotary kilns utilise a rotating cylinder to move the waste through the furnace and fluidised beds fluidise a bed of sand by exposing it to a strong air flow. The most common European method is a moving or sloping grate incinerator.

As the waste is burned it converts to (bottom) ash, flue gases, particulates, and heat, leaving some materials such as metals recoverable for other purposes. Gases pass through air pollution abatement equipment where urea, lime and activated carbon may be added to limit the production of nitrous oxides, acid pollutants and dioxins before being released through a stack. This leaves a residual and toxic flue ash which along with the bottom ash, both requiring disposal in a specialised hazardous waste landfill.

The most robust and proven combustion technology is categorised as moving grate, mass burn technology (KPMG 2021), that can burn MSW on a grate travelling from a feed shaft to the ash pit. The moving grate technology does not require pre-treatment or sorting of MSW, giving it flexibility to accommodate large quantities and variations in waste composition and calorific value (within limits – it cannot operate at low loads of less than 40%, and has an operating envelope that must be adhered to).

Combustion is an extremely mature technology which has been commercially proven for many years. It is not likely that transportation to PICs will be difficult as the technology in its entirety consists of only a combustion chamber or incinerator reactor.

Feedstock requirements are not an issue due to the maturity of the technology; it can easily be scaled down and carried out as batch reactions depending on the type of reactor used. The energy and water requirements may potentially outweigh the benefits, as it is a simple technology which does not use its own energy output to power itself. Like other technologies, the lifetime of the technology depends on many factors, including reactor type and operating conditions.

As it is operated at high temperatures (incineration/burning), safety is always an important factor, however the safety risk can be greatly reduced and even mitigated if operated correctly with caution. If operated correctly with the correct flue gas capture and cleaning technologies, the impact on the environment can be minimised with minimal pollution arising from the combustion technology. As the combustion technology is simple and likely only a single reactor, the footprint and land requirement are small.

Combustion

Figure 6 Combustion Technology Schematic

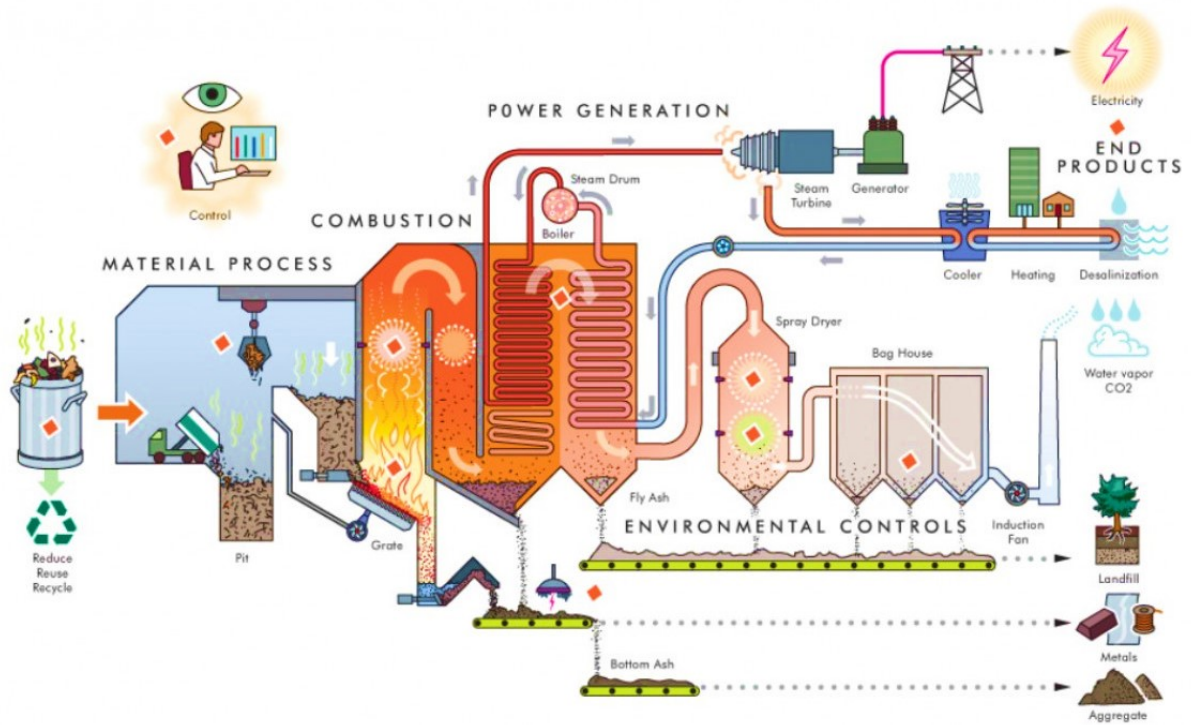

Treatment concept

Combustion reactions can be complete or incomplete. Complete combustion is a reaction carried out in an environment with excess oxygen, with 100% conversion of reactants to products. Incomplete combustion is a partial oxidation process, meaning the reactants do not have full 100% conversion to products, resulting in intermediates being produced also. There are many different types of combustion reactors used to harness heat and energy from the combustion of waste. Some of these include fluidised bed combustion, rotary kilns, moveable step grate incineration, and many more.

Common applications

Mixed MSW.

Products and by-products

Heat, ash.

Energy production

Heat can be used with steam turbines to produce electricity.

Incineration

As previously discussed, incineration was defined as a thermal WTE technology, where heat and energy are not intended to be extracted for use. Therefore, as incineration can be thought of as technically the same as combustion without the benefits, this was disregarded as a technology to be further investigated. The reactors investigated for combustion technology included many incinerators, as these are mostly interchangeable terms. Therefore, the term incineration as defined in this report was given a fatal flaw for energy requirements as there are no benefits through using this technology other than removing waste from the environment, which when compared to combustion technology, is a fatal flaw.

Moving forward, the thermal technologies to be researched further for use as advanced WTE technologies in PICs are pyrolysis, gasification, and combustion.

Pyrolysis

Pyrolysis is the thermal decomposition of material in an inert atmosphere. This means there is no oxygen present. It is an endothermic reaction, which absorbs heat. A key requirement of pyrolysis is that the feedstock is dry and crushed to a specified small diameter. Additionally, the heating applied within the pyrolysis reactor is indirect, meaning that heat is applied through metal walls, shell, and tube and so on. Pyrolysis has the ability to handle various feedstocks, including mixed municipal solid waste.

Operating temperatures of pyrolysis depends on the type of pyrolysis being operated, whereas the operating pressure is generally elevated above atmospheric pressure of about 5 to 20 bar (however there are also atmospheric pyrolysis systems). Given the elevation above atmospheric pressure (1.01325 bar), there is a safety risk to consider. In terms of water and energy requirements for operation, pyrolysis reactors are self-sustaining as they can operate using its heat produced as the energy input, such as the heat from the flue gas, reducing the energy consumption. In addition, there are no cooling water requirements due to its endothermic nature.

There are three main types of pyrolysis technology; these are slow, fast, and flash. There is also microwave-assisted pyrolysis (fast pyrolysis incorporating microwave heating), and all types can be operated in many different types of reactors. Slow pyrolysis is most suited for the formation of biochar as the main product. The rate of heating for slow pyrolysis is the lowest, at about 10°C per second, with an operating temperature reaching 400°C to 500°C, and residence time of 5mins to 30mins. The main product biochar is useful as a fertiliser.

Fast pyrolysis is the most common type used, and is rapid decomposition in the absence of oxygen, operated with a faster heating rate compared to slow pyrolysis – about 100°C per second. In fast pyrolysis, the main product is bio-oil, followed by gases and light hydrocarbons, with minimal amounts of solid biochar. Operating temperature for fast pyrolysis is slightly more elevated than slow pyrolysis, being operated at 400°C to 650°C. Additionally, fast pyrolysis has a much faster residence time of only 0.5-2 seconds.

Ultra-fast pyrolysis (also called flash pyrolysis) has the fastest heating rate, of about 500°C per second. In ultra-fast pyrolysis, the main product is gases and light hydrocarbons, with minimal amount of bio-oil and biochar. Ultra-fast pyrolysis has an even higher operating temperature, of 700°C to 1000°C. Additionally, ultra-fast pyrolysis has a much faster residence time, normally less than half of a second.

There are numerous vendors of advanced waste technologies that utilise a form of pyrolysis, including some examples of small-scale municipal solid WTE technologies that may be suitable for the Pacific Island context. It is an established technology and is available at a range of scales, including modular systems that can be expanded with increase in waste generation.

Some vendors supply the technology in 2-3 shipping containers, as pre-constructed infrastructure for ease of transportation. Depending on the type of pyrolysis and the scale, ease of operation of a pyrolysis plant varies significantly. However, vendors supplying small-scale fast pyrolysis WTE technology requiring only one operator were identified and claim ease of operability.

In terms of scale, there are proven vendors supplying various sized pyrolysis reactors, suitable to the different sized PICs and their varying tonnage of waste streams available as feedstock. Regarding energy requirements for operation, pyrolysis reactors can use their own energy produced to power the system as well as to dry the feedstock, without requiring any further energy inputs.

Plant lifetime is dependent on scale, type of pyrolysis reactor and other factors such as housing requirements to combat degradation in a coastal environment.

A key issue to consider is in the end-product of oil produced as a resource from pyrolysis. Pyrolysis oil, known as bio-oil, is toxic without further treatment (such as hydrogenation). Fast and low temperature pyrolysis oils contain partially decomposed biomass or plastic compounds; higher temperature pyrolysis produces mono and polyaromatic compounds such as BTEX. Potential health impacts need to be explored as a component of any technology feasibility assessment.

In addition to the different types of pyrolysis, there are many different types of reactors that pyrolysis may be performed in. All types of pyrolysis can be carried out as either a batch process or a continuous process. Pyrolysis typically consists of a reactor, a cyclone for the fly ash, and a condenser to condense the pyrolysis oil. The different reactor types include fixed bed reactor, circulating fluidised bed reactor (bubbling bed), rotating cone reactor, entrained flow reactor, ablative (plate or rotary), auger reactor, and more. Reactors differ for each type of pyrolysis process, depending on the products desired, for example, slow pyrolysis uses rotary kiln reactor, screw/auger reactors more suited to biochar production.



Pyrolysis

Figure 7 Pyrolysis Technology Schematic

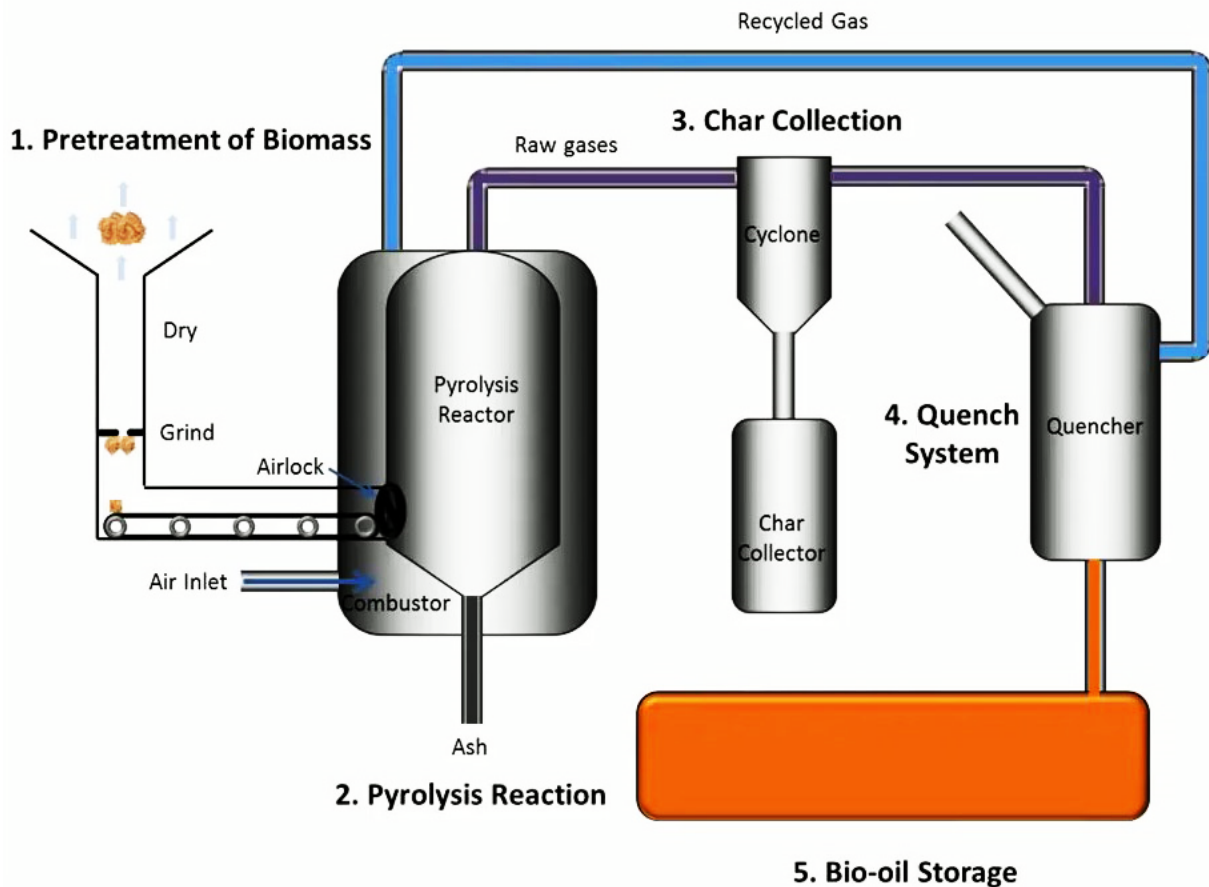

Treatment concept

Pyrolysis is rapid thermal decomposition of material in the absence of oxygen. It is operated at elevated temperatures and pressures. It required the feedstock to be dried and crushed to small particle sizes before entering the reactor. The reactor is used in conjunction with a cyclone and a condenser, dependent on the type of pyrolysis used and therefore the resulting products.

Common applications

A range of feedstocks can be used, including mixed MSW, waste tyres, coal, plastic waste, motor oil etc.

Products and by-products

Slow pyrolysis: biochar.

Fast pyrolysis: bio-oil, followed by gases and light hydrocarbons. Minimal biochar.

Ultrafast/Flash pyrolysis: gases and light hydrocarbons, minimal bio-oil, and very little biochar.

Ash is also produced as an unwanted by product.

Energy production

Synthesis gas (syngas) can be used to produce electricity or synthetic fuel. Burning syngas in reciprocating engines or gas turbines produces electricity while condensing syngas produces synthetic fuel such as heating oil, diesel or DME (after further processing). Bio-oil produced through pyrolysis can be upgraded and fractionated to be used as fuels such as petrol, diesel, kerosene, and more. Solid biochar produced can be used as a soil fertiliser.

Pyrolysis (Fast, Microwave-Assisted)

Figure 8 Pyrolysis Using Microwave Assisted Technology Schematic

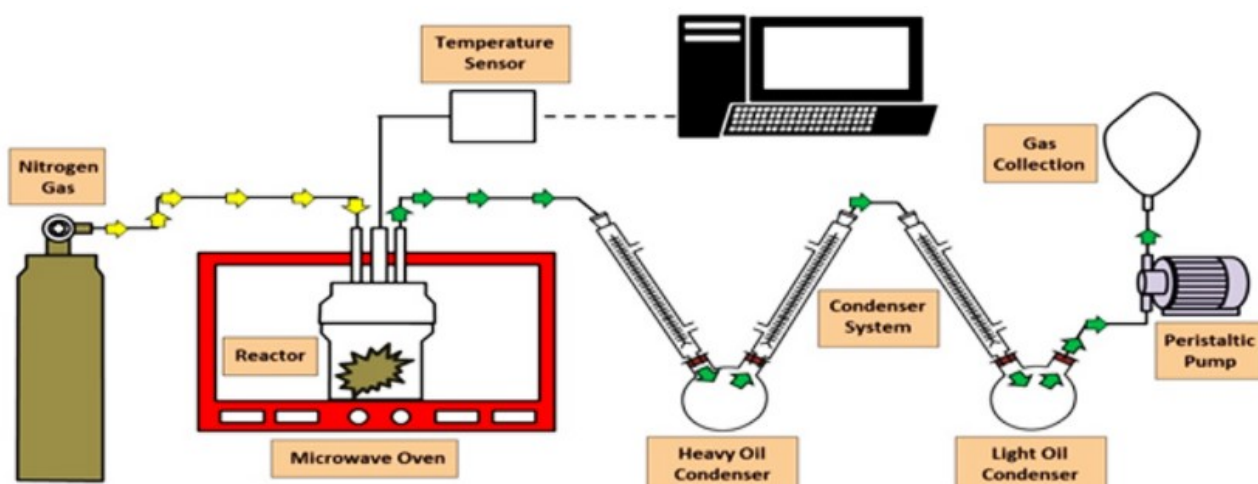

Treatment concept

In addition to the three main types of pyrolysis, fast pyrolysis can also have microwave heating incorporated. This is called microwave-assisted pyrolysis (MAP). Biomass readily absorbs radiation well, resulting in efficient heating of the biomass. This also results in reduced residence times as well as reduced energy requirements, as MAP can initiate fast pyrolysis at much lower temperatures, about 200°C to 300°C compared to 400°C to 650°C.

Common applications

A range of feedstocks can be used, including mixed MSW, waste tyres, coal, plastic waste, and more.

Products and by-products

In fast microwave-assisted pyrolysis, the main product is bio-oil, followed by gases and light hydrocarbons, with minimal amounts of solid biochar.

Energy production

Synthesis gas (syngas) can be used to produce electricity or synthetic fuel.

Burning syngas in a reciprocating engine or gas turbine produces electricity, while condensing syngas produces synthetic fuel such as heating oil, diesel or DME (dimethyl ether), after further processing such as hydrogenation and distillation.

Following pyrolysis, the different products require different treatments for effective use as energy. Bio-oil produced requires upgrading and fractionation. This is dependent on the desired product e.g., diesel, kerosene, etc.

Gases produced are readily combustible, and syngas can produce electricity using turbines. Biochar can be used right away as a soil amendment (fertiliser) to improve the soil quality and sequester carbon.

Ash is produced as an unwanted byproduct which must be disposed of in a contained environment, such as a landfill.

Gasification

Gasification is another form of advanced WTE technology, employing a similar process to pyrolysis, although it differs by degrading waste in a low oxygen rather than an oxygen-free atmosphere. Oxygen levels are kept low to prevent combustion, ensuring that the carbon rich fraction of the feed decomposes to produce syngas. Additionally, gasification is generally operated at higher temperatures above 700 °C, sometimes reaching even higher temperatures (1000°C to 1400°C) if using enriched oxygen or steam. Like pyrolysis, the process also results in the production of a char and a syngas, which can be used to generate electricity or upgraded to produce fuel. Gasification can be operated at either elevated pressures or atmospheric pressures.

The main product is syngas – which is comprised of carbon monoxide and hydrogen gas, as well as some contaminants, meaning the syngas production is normally followed by syngas cleaning. Additionally, a solid char is produced as a byproduct, and heat is also produced.

The syngas can be combusted as-is for heating purposes (such as in boilers or furnaces). Alternatively, it can be used for electricity generation in engines and turbines or upgraded for fuel through syngas cleaning and further upgrading processes (such as Fischer-Tropsch synthesis and fractionation). There are different types of gasification; indirect, direct, as well as plasma gasification.

For the purposes of this report, plasma gasification was deemed as a fatally flawed technology due to its level of maturity, meaning it has not yet been proven as a waste to energy technology for MSW, however process details of plasma gasification have been detailed in **Appendix A**. Indirect gasification was also deemed as fatally flawed for similar reasons.

There are many indirect gasification plants operating worldwide, however not at a scale suitable for PICs. Therefore, indirect gasification is fatally flawed due to minimum feedstock requirements (tend to be large scale only), as well as scalability (difficult to scale down), and immature technology (not a proven small-scale WTE technology). For these reasons, indirect gasification was deemed to be fatally flawed for the purposes of this report, however process details of this technology can be found in **Appendix A**.

Gasification has proven maturity, as it is not a new technology and is currently sold by various vendors as an advanced WTE technology unit. More research is required into the vendors' specific type of gasification technology – gasification and reactor type to ensure it is suitable for the given feedstock. Most types of reactors can be classed as easy to moderate operation, depending on the reactor and plant size – which is assumed to be smaller scale for PICs, therefore a less complex operation with only one reactor is likely.

Feedstock requirements depend on the size of the reactor, with smaller reactors requiring a lower minimum feedstock. Water and energy requirements are low, as reactors have the ability to supply their own energy requirements through the use of heat exchangers. Similar to pyrolysis, the plant lifetime is dependent on type and scale as well as implementing proper maintenance.

Similar to pyrolysis, there are many different types of gasification reactors available. These include fixed bed, circulating fluidised bed, entrained bed, as well as supercritical water gasifiers.

Gasification (Direct)

Figure 9 Direct Gasification Technology Schematic

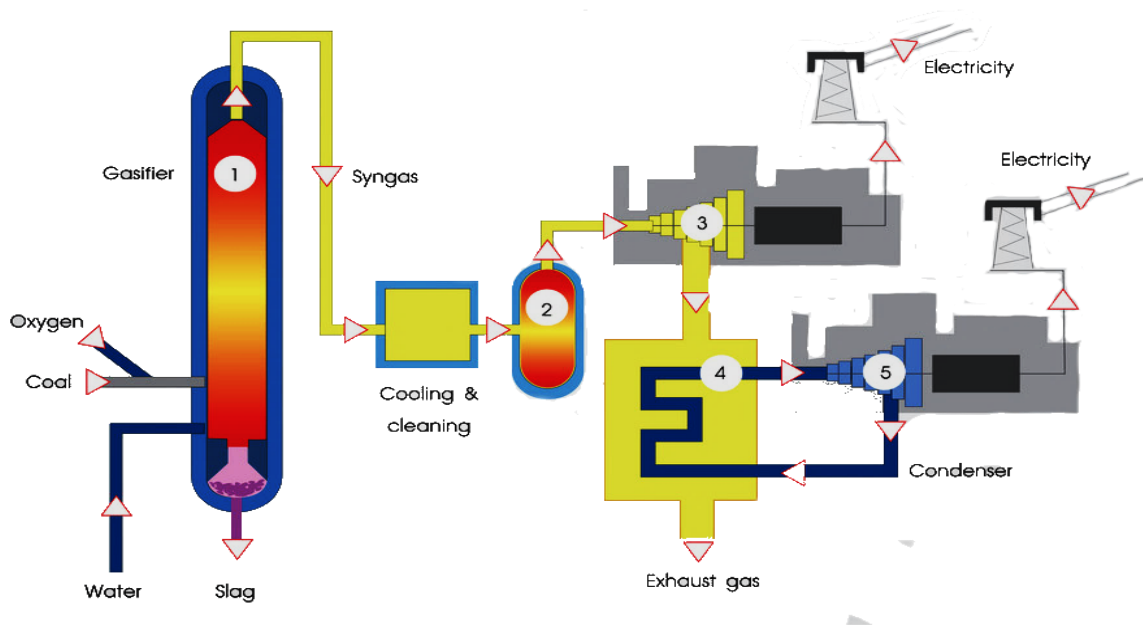

Treatment concept

Direct gasification is where the feedstock is directly heated. This means that the heat required for gasification is provided using a combustion chamber, combusting a portion of the feedstock; also known as incomplete combustion. This form of gasification requires an air separation unit (ASU) to produce nitrogen free gas. Direct gasification occurs in a single reaction chamber and produces syngas of a lower heating value compared to the syngas produced through indirect gasification. As stated above, gasification is operated at elevated temperatures, with direct gasification normally operating at 700°C to 1000°C.

Common applications

Coal, wood chips, mixed MSW (requires drying).

Products and by-products

Slag, syngas.

Energy production

Syngas produces energy through combustion and can also be used to produce chemicals and liquid fuel.

Biological Advanced Waste Technology Options

Anaerobic Digestion Process

Anaerobic digestion (AD) is essentially the sole option for biological treatment that generates energy as an output. Unlike thermal treatment that favours dry, high calorific wastes as feedstock, anaerobic digestion generally prefers wet, putrescible material with high organic biodegradable content. Various AD technologies are available including plug flow, up flow anaerobic sludge blanket (UASB), continuous stirred tank reactors, anaerobic co-digestion, and household and community biogas digesters. These technologies employ anaerobic microorganisms to decompose organic wastes in closed anaerobic reactors under mesophilic or thermophilic conditions.

Anaerobic digestion (AD) involves processing of organics in some oxygen-starved environment which leads to the production of biogas (a substantial proportion of which is methane) and digestate. The biogas can then be used to produce electricity, cleaned, and upgraded into renewable natural gas (RNG), or be used as a direct fuel in furnaces or boilers. In general, there are three different forms of AD processes: wet AD, plug flow AD, and dry AD. Wet AD is suitable for feedstocks with low solids content (i.e., food waste), whereas plug flow and dry AD are compatible with feedstocks with increasing solids content (i.e., green waste including leafy garden waste).

AD facilities typically process the following primary feedstocks: residential source separated organics (SSO), animal manure, fats, oils, and grease (FOG), agricultural residuals, and food processing residuals. In an AD facility, feedstock is received in a building, deposited onto a tipping floor or pit where the material is then transported to pre-processing equipment to prepare material for digestion. Feedstock is pre-processed to remove contaminants (such as plastics, metals, glass, packaging, bones, and other non-organic items) that are harmful to the AD system components such as tanks, pumps, and piping. Pre-processing typically involves hammermills or presses that physically sorts the feedstock into the organic fraction, light fraction plastics, and heavies or grit material. The organic fraction is turned into a slurry that feeds the digestion tank, while the other material is removed as contamination.

Once the material finishes the pre-processing stage, the material (slurry) is generally contained in a buffer feeding tank to provide a consistent flow of feed to the digester system. The process of pasteurisation may be used before or after digestion to reduce pathogens and generate a safe fertiliser end-product. After digestion, the liquid digestate is either stored in a digestate storage tank for land application or dewatered to generate dewatered digestate for composting or direct land application and wastewater for treatment.

Biogas, a mixture of methane, carbon dioxide and other trace gases, is generated for use as heat energy or conversion into electricity using conversion generators. Other by-products are solid, or slurry discharges known as digestate, and liquid effluent.

As per the fatal flaw analysis, the following types of AD processes have been excluded due to their unsuitability for the Pacific Region and Timor-Leste:

- Continuously Stirred Tank Reactor Anaerobic Digestion
- Upflow Anaerobic Sludge Blanket (UASB) Anaerobic Digestion

These technologies are more applicable for wastewater treatment processes producing large volumes of process waste.

Given the significant proportion of organic waste within MSW, anaerobic digestion technologies are a broadly accepted and tested technology for the management of organic materials within MSW and the creation of energy. However, this method can only be used in the treatment of organic waste and thus has some limitations as an alternative to landfill. AD requires segregation of feedstock rather than the treatment of the entire MSW stream.

There are four main stages to processing waste through an AD system, as outlined in

Figure 10:

- Feedstock Receiving and Pre-processing
- Anaerobic Digestion
- Biogas Capture and Utilisation
- Digestate Handling and Processing

Figure 10 Schematic of a Typical MSW Organics Processing AD Facility

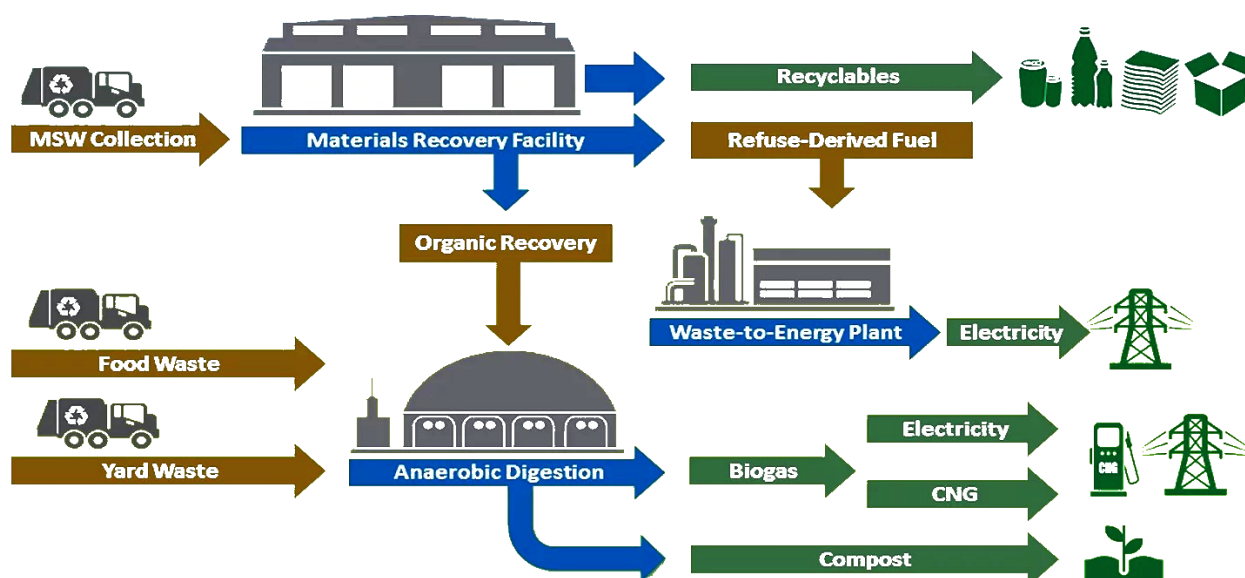

Given the complexity in the pre-processing of mixed MSW, often AD systems are linked to source separation of organic materials.

Within the digester process itself, AD proceeds in four stages, as shown in **Figure** :

- hydrolysis that breaks down complex materials,
- acid formation (acidogenesis),
- fermentation (acetogenesis), and
- generation of biogas (methanogenesis).

Figure 11 Four Stages of Anaerobic Digestion

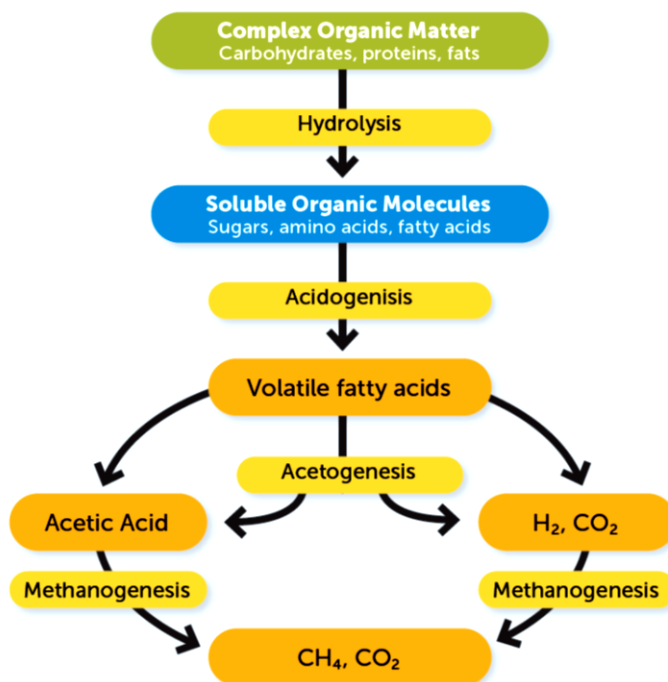

Hydrolysis is typically the slowest step in anaerobic digestion as it is the initial step that breaks down large, complex organics into smaller organic molecules. These hydrolysed materials are then broken down in the acidogenesis stage into various organic acids and alcohols which are further fermented in the acetogenesis stage to form short-chain volatile fatty acids and hydrogen. The final step, methanogenesis, is the slowest step as it converts the products of acetogenesis into methane gas, carbon dioxide and other trace gases.

Anaerobic digestion functions under two operating temperatures, either mesophilic 35°C or thermophilic 55°C, and because it mostly treats wet materials, water inputs are low. The operational energy and water requirements are minimal in comparison to other technologies. The end-product, biogas, can be used directly as fuel or converted to electricity for on-site use.

The descriptions of technology options in this section present an overview, but not all technologies cater well for municipal solid waste. Some technologies are better suited to a homogenous feedstock, with high volumes and predictable inputs, for example, industrial effluents or animal feedlot waste. Unsorted municipal solid waste is significantly heterogeneous, with considerable variations in moisture levels that may be subject to seasonal variations. Feedstock quantities and composition are also variable over any given day. Given this variability, MSW is more complicated to process and treat.

AD plants creating energy from MSW often require significant pre-sorting facilities to remove unsuitable components, with source segregation systems in place to divert unsuitable materials such as metals and glass.

The physical and chemical characteristics of the organic waste are considered important parameters for designing and operating anaerobic digesters as they affect biogas production and process stability during AD. The main characteristics to consider include moisture content, volatile solids content, nutrient content, particle size, and biodegradability.

The selection of an AD technology is key to the overall operating success of the project. Pre-processing and digestion technologies that are not appropriate for the condition of the incoming feedstock will be quickly overwhelmed and can potentially cause the project to fail.

The composition of the incoming feedstock is an important consideration when assessing AD technologies, as organic feedstocks vary physically, chemically, and biologically.

The increased implementation of mixed waste processing plants in Europe has pushed the development of AD technologies that are designed and tested to process mixed MSW. The organic fraction of MSW has a higher contamination rate than most source-separated organics (SSO) streams and contains more plastic bags.

The design scale and operational requirements are determined by the hydraulic retention time, organic loading rate, total solids, temperature, and mixing process.

Table 9 Key Design Considerations for AD

Design Element	Principle	Recommended Conditions
Hydraulic Retention Time	Hydraulic retention time (HRT) is the average time that feedstock remains in a digester. $HRT = V/Q$ Where V: Digester volume Q: Organic loading rate (Labatut and Pronto, 2018)	A shorter HRT allows a higher loading rate but is more at risk of causing acidification. Longer HRT is necessary for digesting less degradable lignocellulosic wastes. Hydraulic retention time for a mesophilic (35°C) digester generally takes 15 – 30 days (Schnaars)
Organic Loading Rate	Organic loading rate (OLR) refers to the amount of organic material entering the digester per unit of time (e.g., per day) Common units include Volatile Solids (VS) or Chemical Oxygen Demand (COD) basis kg/m ³ •d and g/L•d	Avoid overloading because waste can quickly hydrolyse, acidify and cause VFA accumulation and inhibit methane production. Feed rate should be consistent and at a constant rate to minimize bacterial upsets High-rate digesters typically operate between 1.6 to 6.4 kg/m ³ •d
Total solids	Total solids (TS) refer to the dry matter content of a material inclusive of its organic or inorganic nature, commonly indicated in percentages.	Moisture content (and therefore total solids) must be in the right range to support microbial growth. Wet digestion operates at <15% TS, while dry or high solids digestion >15 to 20% TS. A drier, high solids system benefits in reduced reactor size, liquid/solid separation system and lower energy demand, however, is much harder to control.
Temperature	Two temperature conditions: Mesophilic, 35°C Thermophilic, 55°C	Mesophilic degrades materials slower than thermophilic reactors and yields less biogas. However, the heating energy demand and equipment costs are lower compared to thermophilic digesters.

Monitoring of the anaerobic digestion process is important to indicate the health of the system or its impending failure. Bacteria responsible for methane production are sensitive to various process conditions including the presence of toxins, elevated feedstock loading, sudden temperature changes and pH changes.

If acidic conditions set in, usually from an accumulation of volatile fatty acids not being converted fast enough to methane, then the formation of methane can be suppressed, ceasing digestion process and biogas production completely.

This is a state called “souring” where the digester becomes odorous, resulting in partially decomposed materials and low gas production. To recover a ‘soured’ digester is a time consuming and expensive feat. Suggested monitoring parameters are shown in **Table 10**. Having high levels of alkalinity is important to self-regulate pH changes in the presence of acids/bases which helps prevent digester imbalances. The key to identifying an upset digester is for digesters to continuously operate within the parameters below, and more importantly to keep within a Volatile Fatty Acids (VFA): Alkalinity ratio of 0.34:1 and 65-70% methane gas. Any deviation from its consistent pattern is an indication of a troubled reactor and steps should be taken to identify the cause and take necessary remedial actions.

Table 10 Key Process Parameters of a Healthy Digester

Parameter	Typical Acceptable Range
pH	6.5 – 7.5
Alkalinity	More than 100 mg/L
VFAs	Less than 4000 mg/L
VFAs: Alkalinity ratio	0.34:1
Methane	65 – 70%
Carbon dioxide	30 – 35%

In cases where the use of complex analytical instruments and data loggers for continuous monitoring is not possible, then regular monitoring using grab samples are utilised in some technologies. For example, community biogas reactors may benefit from simple monitoring of the digestate pH and temperature using off the shelf probes, or perhaps a small investment for monitoring biogas content using handheld meters. Although this approach demonstrates the reactor condition, the response is slower. Digester souring is likely to have set in and alkalinity already exhausted by the time a pH change is detected.

Toxicity is another concern that can endanger anaerobic processes because of severe ammonia and sulfide levels. These compounds are brought about to the digesters from nitrogenous feedstock such as meat waste, or waste with high sulfur compounds, including proteins which are common sources of sulfide in MSW.

Nitrogen at moderate levels (50 to 200 mg/L) are beneficial for cell growth and microbial development, however, at elevated levels (1500 to 14,000 mg/L) can hinder the digestion process and drop the methane production by 50%. Controlling the nitrogen concentration by limiting the carbon to nitrogen ration (C:N ratio) of incoming feedstock to 30:1 can help prevent ammonia toxicity. Sulfide concentrations above 50 mg are known to exhibit inhibitory effects.

Digestate is a by-product of anaerobic digestion characterised as a wet mixture of solid or semi-solid nature that is rich in nutrients. Raw digestate can be expected to accumulate in the range of 900 kg/m³ to 1000 kg/m³ for high solids digesters because of the undigested garden waste portions. Wet digesters tend to have higher unit weight values at 1200 kg/m³ and above due to solids having higher density (*Environment Canada, 2013*).

Digestate from wet digesters are first dewatered to 50% moisture content before being applied to land as fertiliser or as a feedstock for further composting processes.

Further drying to 10% to 15% moisture content allows for pelletising and fertilisation options. With dry digesters, the digestate is often composted directly without requiring any dewatering.

The biogas generated from the anaerobic digestion process consists primarily of methane gas and carbon dioxide, as well as other trace gases at the following proportions:

- Methane (CH₄) : 60% by volume
- Carbon dioxide (CO₂) : 40% by volume
- Hydrogen sulfide (H₂S) : 200 to 4000 ppm
- Trace gases : Nitrogen, ammonia, hydrogen, VOCs

Hydrogen sulfide and VOCs when present in excessive amounts can cause corrosion to equipment due to their acidic nature. In addition, hydrogen sulfide is life-threatening at 100 ppm by volume especially in confined spaces.

The biogas yield or the amount of biogas produced for each tonne of feedstock is very much dependent on the type of material input. Feedstock with high biodegradability such as food waste, produces more biogas (144 m³/t) compared to less degradable highly cellulosic materials like leaves (23 m³/t) or grass (34 m³/t). In PICs, the garden waste can include very fibrous materials such as palm leaves, which have a high percentage of cellulose. The highest biogas yields can be expected for fats, oils, and grease (390 m³/t) although their poor bioavailability may result in longer retention times.

Energy potential of methane is 37 MJ/m³. The amount of energy obtainable from biogas is reliant on the methane content, for example, biogas with 60% methane can generate about 22 MJ/m³ (*Environment Canada, 2013*). This energy can be used directly as a fuel product or undergo further biogas cleaning to remove other gases and moisture prior to conversion into electricity.

Managing the ever-increasing load of municipal solid waste (MSW) is one of the biggest challenges for municipalities all over the world. As the organic fraction of MSW accounts for more than 40% of the total MSW generated, and up to 60% in some poorer economies with less consumable imports and tropical climates, AD provides a solution applicable in many settings.

Common feedstocks utilised are biodegradable waste such as:

- Municipal, commercial, and industrial food wastes
- Agricultural wastes (e.g., slurries, poultry litter and manure)
- Wastewater and sludges from industrial waste treatment
- Food/beverage processing waste
- Energy crops (e.g., maize, grass, and silage)

Biogas production from food waste, along with other renewable organic sources such as agricultural waste, has been proposed as a solution for waste management and energy recovery in the coming decades due to the benefits of energy savings, reduced emissions, and improved waste management.

Wastewater treatment plant sludges are also an option for feedstock, as AD reduces the weight of solids, and associated disposal costs.

Plug Flow Anaerobic Digestion

Plug flow AD reactors are the most adaptable in treating mixed feedstock with high solids content, such as food waste or the organic fraction of MSW. Their primary objective is inclined more for waste management rather than biogas yield. This provides a more flexible operation that allows for longer retention times and reduces the risk of sudden imbalances brought on by inconsistent feedstock quality or quantity. As such, this has been selected as the AD option that is potentially the most suitable for PacWastePlus participating countries. Other options are described in **Appendix A**.

Figure 12 Plug Flow AD Schematic

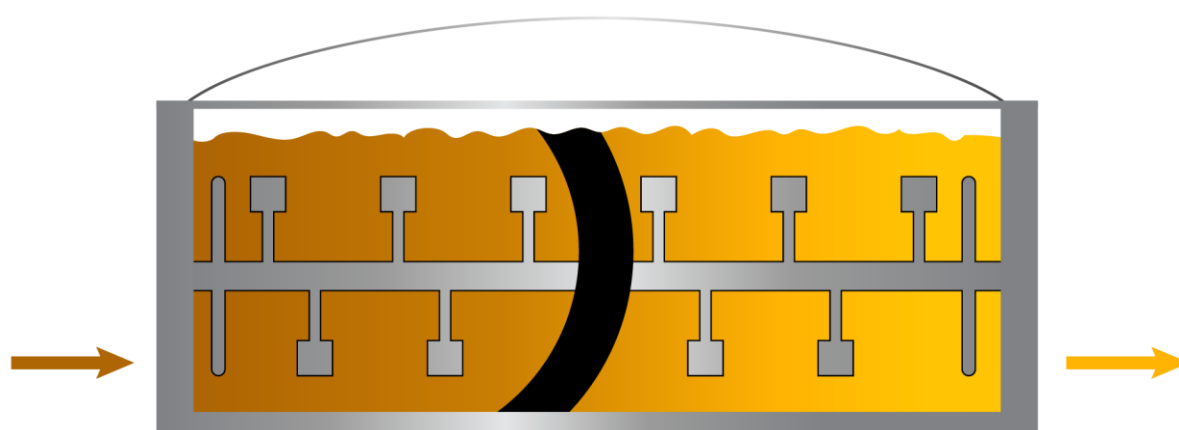

Treatment concept

Plug flow digesters are elongated reactors (usually at a 5:1 ratio of length: width) made of steel, fiberglass, or reinforced concrete, and are insulated and heated with a gas cover for biogas collection (Singh & Prerna, 2009). This gas cover or roof can either be a fixed roof with negative an attached negative pressure pipe, or a floating roof for biogas collection and storage.

It is common for plug flow and percolate bunker digesters to use shredding as a primary pre-processing step and then send the feedstock directly to the digester reactor. Plug flow or “high solids” reactors do not involve continuous mechanical mixing but instead formulate a thick high solids slurry (TS typically in the 15% to 30% range) that flows longitudinally through vessels that are generally long and narrow. During this movement, each successive plug of material demonstrates different composition than the one before and behind it; with respect to AD, this means that subsequent plugs are additionally digested while previous plugs are less digested. The need for a high solids slurry to prevent settling along the longitudinal pathway generally means that bulking agents such as garden waste or soiled paper/cardboard needs to be added. Digesters contain widely spaced paddle arms to slowly move the contents forward as a plug while creating a minimal amount of mixing. The reactors have a headspace above the material where biogas collects and is syphoned from the reactor.

Plug flow designs are appropriate for waste with a high solids content in the range of 11% to 20% TS and has a typical retention time of 20 days (Cantrell et al., 2008). There are both vertical and horizontal plug flow digesters on the market.

Common applications

Organic fraction of MSW.

By-products

Effluent, digestate and biogas.

Energy production

Methane gas and electricity.

Household and Community Biodigesters

There are over 20,000 full-scale AD systems in the world and over 1,000 new projects per year. However, the process for organic waste can still be optimised. One way to do so is to use small-scale digestion. Small-scale digestion plants (sometimes referred to as micro-scale digestion) are AD plants that are smaller, less expensive, and easily self-sufficient.

These units can be utilised on farms, or at a small community scale to capture and utilise a source of clean energy. There is also a growing trend for modular approaches (such as containerised, mobile units, or “plug and play” systems (*Lemonade 2020*)).

Household and community scaled bio-digestion involves the production of biogas, with production units typically below 80 kW. Most units installed on farms have a power generation capacity between 100 kW and 300 kW, while some industrial units exceed 1,000 kW.

The scale of this type of AD facility digestion project is a feedstock of 200 tonnes to 5000 tonnes of organic waste per year. The range in scale correlates to feedstock availability, but also energy outputs, with a 5000-tonne facility producing a 25-fold increase in biogas yield compared to a 200-tonne facility.

The rationale for these facilities includes:

- Capacity to generate power and heat for on-site use, potentially saving money on energy at a household or small community level
- Minimisation of transport and waste disposal costs through on-site small-scale treatment
- Reduction in GHG emissions related to livestock manure
- Reduction in GHG emissions through utilising waste to produce energy
- Odour reduction by improved management of manure
- Digestate can be used as a liquid fertiliser input for farms and gardens

Small fixed-dome digesters consist of an inlet trough, a lower fermenting reservoir with a rigid, immovable collection dome capping it, and some type of overflow relief. Several different types of fixed dome digesters exist, but the most popular is the Chinese design, which is typically built of gas-sealed brick and mortar or cement. The simple design of a fixed-dome digester and its lack of moving parts means that if constructed well, it will last for many years.

Most small fixed-dome digesters are constructed underground, which means that they are hard to access for cleaning and maintenance. Since methane gas inside the collection chamber is being pushed out only by the pressure of other methane, the gas pressure coming out of the collector is subject to fluctuations. Therefore, in order to use the biogas for cooking or other applications, a regulating device is commonly added.

Household or Community Anaerobic Digestion

Figure 13 Community Anaerobic Digestion Schematic

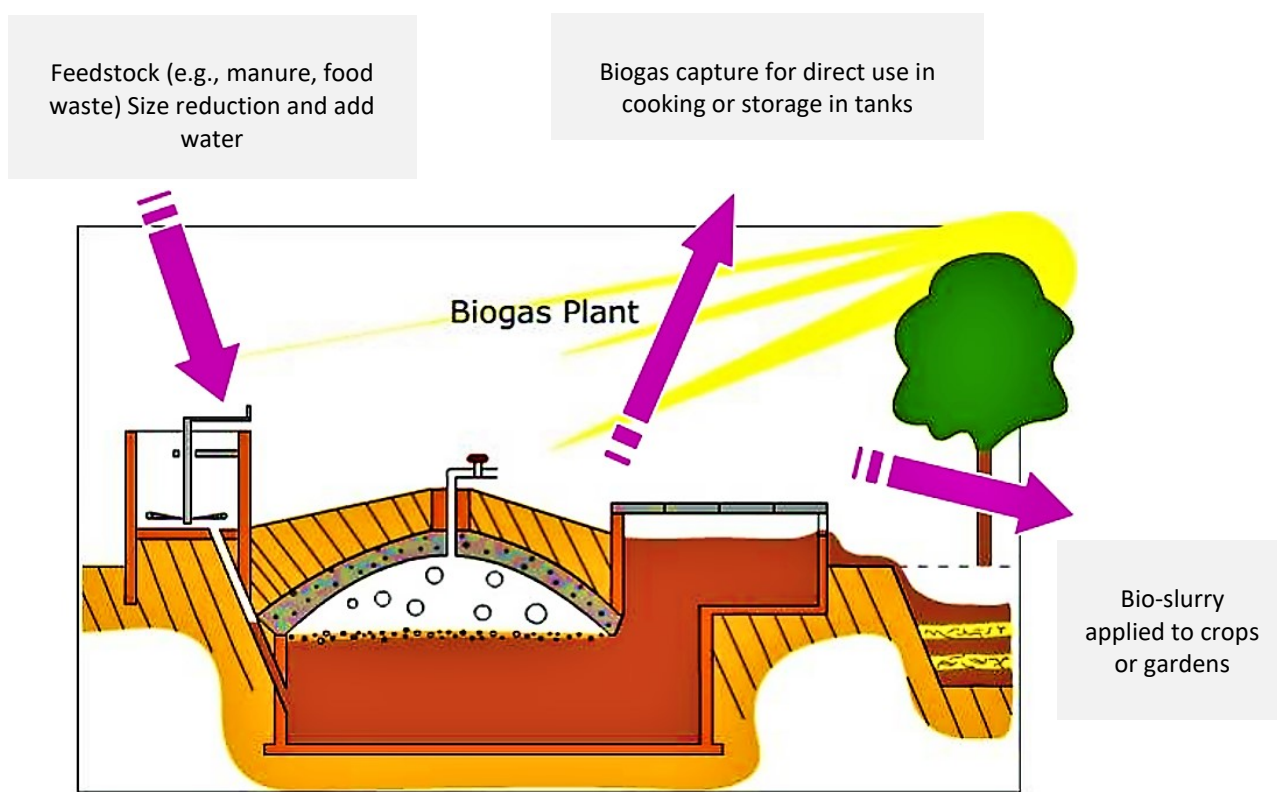

Treatment concept

A simple, conventional anaerobic reactor construction requiring minimal installation and operation. The structure consists of a tank with headspace for biogas accumulation, an inlet pipe for feedstock and an outlet pipe for digestate flow. Mixing and heating are usually absent, with the tank installed underground to decrease heat loss via convection. The easy set up and operation favours the biogas application among communal households and farms.

Common applications

Farming waste, particularly manures from piggeries or dairies.
Food waste.

By-products

Effluent, digestate and biogas.

Co-Digestion

Co-digestion is effectively an AD process that utilises more than one feedstock. Co-digestion is the simultaneous digestion of a homogenous mixture of multiple substrates. This technique combines feedstocks to achieve a complementary nutrient and/or moisture balance and enhance biological processes. Co-digestion of wastewater treatment sludge with source separated organics is increasingly considered as a method to boost biogas yields and use excess digester capacity. Dairy or wastewater digesters can have excess capacity, making co-digestion a viable option. In addition to diverting food waste and fats, oils and grease from landfills and the public sewage systems, these high-energy materials have at least three times the methane production potential (e.g., biogas) of biosolids and manure.

However, this approach requires sound regulation of feedstocks to optimise or maintain reactor performance. In existing wastewater treatment plants, adding source separated organics at a loading rate of 10% to 20% on a volatile solids basis resulted in improved biogas yields. There is significant research ongoing in co-digestion, with co-digestion principles being applied to existing facilities and in the design of new facilities to optimise waste management outcomes and enhance biogas yields.

Figure 14 Co-Digestion Schematic

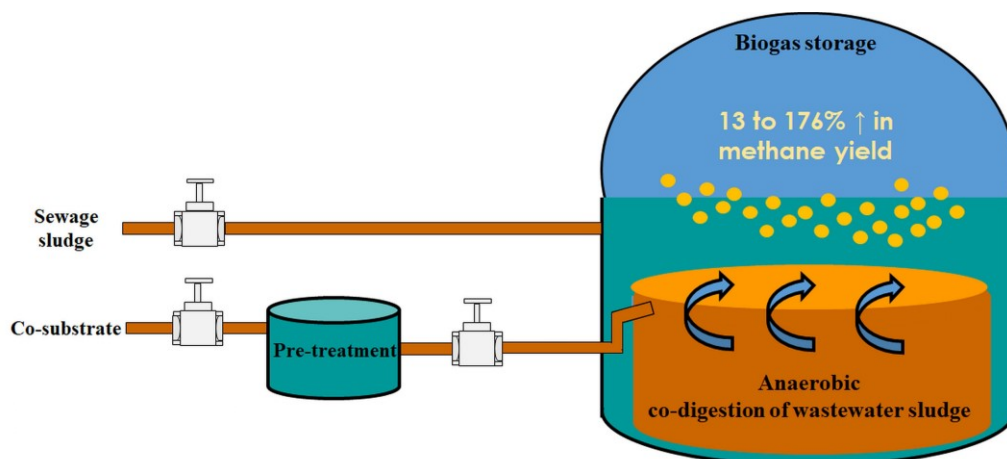

Treatment concept

Most anaerobic digestion involves a single type of feedstock or mono digestion. Co-digestion is the concurrent digestion of two or more types of feedstocks, for example, food waste with sewage sludge, or industrial wastewater treatment sludge with manure, and so on. The application of co-digestion is suitable for locations with insufficient volumes of a single feedstock, or to improve economic viability of AD plants. In addition, the combination of feedstock can overcome the deficiencies of mono-digestion by improving nutrient deficits and biogas yields.

Common applications

Wastewater treatment plants, food waste, FOG, organic industrial waste, agricultural waste.

By-products

Effluent, digestate and biogas.

Energy production

Methane gas and electricity.

Mechanical Treatments

Mechanical treatment of waste is often a pre-treatment step to another treatment process, such as thermal treatment. Mechanical treatment produces a refuse-derived fuel (RDF), which can then be used in combustion, pyrolysis, and gasification. Mechanical treatment usually consists of crushing, drying, then pelletising raw waste, readying it for further treatment.

Refuse-derived fuel (RDF) is the process of removing the recyclable and non-combustible materials from MSW and producing a combustible material, by shredding or pelletising the remaining waste.

As a complete treatment system, this was not considered further as an advanced waste technology. However, coupled with other technology, this can be important in making WTE more viable. For example, having locally based mechanical treatment plants, with basic sorting systems (mostly manual) to separate materials to transport to a central WTE facility, may be an important part of feasibility considerations. Logistics, transport distances, and proposed technologies would need to be considered on a case-by-case basis to understand the costs and benefits of this approach.

Mechanical treatment as a standalone system was fatally flawed as it cannot solely provide energy unless coupled with another process. Some further technical detail for this option is provided in **Appendix A** for completeness of information, however, it is viewed as unsuitable as a standalone system for the Pacific Island context, but potentially viable as a pre-processing component integrated into a WTE plant.

Technology Choice Considerations

A critical issue for all advanced waste technologies are the requirements for operational capacity and ongoing maintenance, except for small-scale biogas reactors. Each of the technologies will have different requirements, but all require a degree of operational expertise and ongoing support as a pre-requisite for success. Maintenance requirements must be carefully planned, with servicing, repairs and potential refurbishment factored in from the outset. Long term operational support, training, and maintenance contracts should be considered. Several countries in the region do not have adequate technical skills in-country, or strong institutional cultures of proactive repairs and maintenance, a situation exacerbated by harsh coastal environments. As such, longer term partnership models may provide a sound option.

Thermal Technologies – Advantages and Disadvantages

There are many advantages and disadvantages associated with each type of advanced thermal WTE technology. Additionally, each major process has varying advantages and disadvantages relating to the specific sub-process used or reactor type used.

Therefore, the key advantages and disadvantages for overall combustion, pyrolysis, and gasification processes have been tabulated below in **Table 11**, **Table 12** and **Table 13** respectively.

Table 11 Combustion Advantages and Disadvantages

Combustion	
Advantages	Disadvantages
<ul style="list-style-type: none"> • Reduces waste (up to 85%) whilst providing a useful energy output at the same time. Economic advantage with regarding operating costs when using waste as feedstock. • Less pre-treatment of waste feedstock required compared to pyrolysis and gasification. • Generally lower operating temperatures compared to gasification, resulting in reduced operating costs and a reduced safety risk. However, combustion has higher operating temperatures than pyrolysis. • Relatively simple to operate and transport due to modular units available. Additionally, this makes them easy to scale up or down by simply adding more units. • Mature technology, even for conversion of municipal solid waste to energy. • Effective energy capture. The heat produced in the process is converted to steam to run turbines and generate electricity. Some incinerators can also capture the heat given off and feed it back into communities for general heating, hot water supply and other uses. A typical electricity only combustion system can operate at electrical efficiencies from 14% to 24% with a maximum efficiency of approximately 27% for the most modern facilities. • Proven technology with many case studies of varying scale and approaches. 	<ul style="list-style-type: none"> • Excess GHG emissions. The emissions produced through combustion of waste are far greater than those produced through other thermal technologies such as pyrolysis and gasification. This is due to the excess oxygen environment. • Limited range of products compared to pyrolysis and gasification. Only steam is produced as a useful product, but it can be converted to electricity. • Potentially difficult to gain required consent and other specific legal requirements and sign off due to nature of technology – it has a negative reputation as it is seen as “burning rubbish”. Older technologies with less rigorous pollution control led to releases of dioxins and heavy metals, adding to negative perceptions of the technology, despite improvements in emission controls. • Results in a higher amount of ash requiring further contained disposal such as landfilling compared to that of pyrolysis technologies. • Emissions are less contained compared to pyrolysis and gasification technologies. Relies a lot on flue stack pollution mitigation technologies to be failsafe. • Longer residence times, compared to pyrolysis and gasification.

Table 12 Pyrolysis Advantages and Disadvantages

Pyrolysis	
Advantages	Disadvantages
<ul style="list-style-type: none"> • Reduces waste whilst providing a useful energy output at the same time. Economic advantage with regarding operating costs when using waste as feedstock. • Low air pollution. The oxygen starved environment means no dioxins nor ultrafine particulate matter is produced (or at least very minimal amounts). • Range of products. The different types of pyrolysis and operating conditions allow different products to be produced with different applications, whether that be solid biochar, liquid bio-oil, or syngas. • Controlled emissions. All emissions are easily captured within the syngas, providing easy removal through syngas cleaning, allowing better containment of contaminants. • Efficient. Pyrolysis is a very efficient process with high conversion of feedstock to products (e.g., high bio-oil yield). Although, if electricity is the desired product, pyrolysis efficiency is lower, similar to that of combustion technologies. • Easy to operate and transport due to modular units available. Additionally, this makes them easy to scale up or down by simply adding more units. • Liquid products have a similar heating value compared to fossil fuels. • Can be used to convert a wide range of waste streams. 	<ul style="list-style-type: none"> • Unwanted by-products produced. Inert bottom ash is produced which requires contained disposal such as landfill. • Most pyrolysis types require some form of pre-treatment of feedstock. This includes crushing and drying the MSW before entering the pyrolysis reactor. • Elevated temperatures. The required elevated operating temperatures are a disadvantage from both a safety and an operating cost perspective. • Potentially difficult to gain required consent and other specific legal requirements and sign off due to nature of technology – it has a negative reputation as it is seen as “burning rubbish”. • Significant financial capital expenditure, especially compared to combustion technology, however, this was not viewed as a fatal flaw given the potential for externally funding (providing it meets donor or lender criteria). • Elevated operating pressures (above atmospheric pressure) pose an additional safety risk, especially in conjunction with the elevated operating temperatures.

Table 13 Gasification Advantages and Disadvantages

Gasification	
Advantages	Disadvantages
<ul style="list-style-type: none"> • Low air pollution. Similar to pyrolysis, gasification takes place in a low oxygen environment, which limits the formation of dioxins and SOx and NOx. • Operated at or near atmospheric pressure. This is an advantage with respect to operating energy requirements and therefore operating costs, as well as an advantage with respect to safety. • Reduces waste whilst providing a useful energy output at the same time. Economic advantage with regards to operating costs when using waste as feedstock. • Range of products. The different types of gasification and their operating conditions allow different products to be produced with different applications, whether that be liquid bio-oil, or syngas. • Controlled emissions. All emissions are easily captured within the syngas, providing easy removal through syngas cleaning, allowing containment of contaminants. • Efficient. Gasification is a very efficient process with high conversion of feedstock to products (e.g., high bio-oil yield), especially when compared to combustion technologies. • Easy to operate and transport due to modular units available. Additionally, this makes them easy to scale up or down by simply adding more units. • Mature technology, even for conversion of municipal solid waste to energy. • Can be used to convert a wide range of waste streams. 	<ul style="list-style-type: none"> • Elevated temperatures. The required elevated operating temperatures are a disadvantage from both a safety and an operating cost perspective. • Potentially difficult to gain required consent and other specific legal requirements and sign off due to nature of technology – it has a negative reputation as it is seen as “burning rubbish”. • Significant financial capital expenditure, especially compared to combustion technology, however, this was not viewed as a fatal flaw given the potential for externally funding (providing it meets donor or lender criteria). • Longer residence times compared to pyrolysis; however, gasification is faster than combustion technology. • Results in a higher amount of ash requiring further contained disposal such as landfilling compared to that of pyrolysis technologies.

Biological Technologies – Advantages and Disadvantages

The three biological treatment options that were not viewed as having fatal flaws in the Pacific context are plug flow AD, co-digestion and household or community scale biogas reactors. Table 16 provide an overview of the advantages and disadvantages of each of these respective systems.

Table 14 Plug Flow Advantages and Disadvantages

Plug Flow Anaerobic Digestion	
<p>Advantages</p> <ul style="list-style-type: none"> • Less water consumption as the system can operate with low water inputs or without liquid addition. • The flexibility to operate under drier conditions allows for a higher volume load of organic material per cubic meter of digester volume. • It is sufficient to use smaller dewatering equipment considering that a drier digestate and less effluent volume is produced. • Plug flow requires a longer time for substrate to pass through the reactor, improving sterilisation process of the output. 	<p>Disadvantages</p> <ul style="list-style-type: none"> • The anaerobic fermentation is slower and retention time longer than other AD systems. • Having a long narrow design increases susceptibility to dead zones (where there is no microorganism activity) usually near corners, which can affect process performance. • Requires more robust pumps and secondary equipment (to prevent dead zones), thus adding further costs. • The drier process means less water is available to dilute the salts within the mix, presenting higher risk for salt concentration reaching toxic levels unless managed carefully.

Table 15 Co-Digestion Advantages and Disadvantages

Co-Digestion	
<p>Advantages</p> <ul style="list-style-type: none"> • The combination of different feedstocks can help improve nutrient balance and digester performance leading to higher biogas generation. • The digestibility of feedstock with poor characteristics e.g., floating wastes, wastes with inhibiting components etc., can be compensated by other materials that instead complements and rectifies the shortcomings of the main material. • Ability to target high-value feedstock that allows for higher biogas production. 	<p>Disadvantages</p> <ul style="list-style-type: none"> • The variable feedstock quality and quantity increases the risk of introducing fluctuating organic loading and inhibitory substances e.g., antibiotics, copper etc. • Increased mixing and pre-treatment are required to prepare the different substrates into one homogenise and compatible feedstock. • Likely presence of pathogens derived from certain feedstock mixtures (e.g., with manure or food waste addition), would require hygienisation compliance and the associated additional permits, infrastructure, and management. • Restrictions of land use for produced digestate.

Table 16 Community Biogas Reactor Advantages and Disadvantages

Community Biogas	
<p>Advantages</p> <ul style="list-style-type: none"> • Simple, basic, compact design requiring minimal initial cost. • Viable where land is scarce, especially if digesters are built underground. • Easier system for community to maintain because the procedures to improve mixing or heating are nonessential with these digesters. • Offers a two-pronged solution in waste disposal and energy demand for underprivileged communities through a cheap, viable and renewable method. • Can provide accessible clean technology at a grass root level and improve living conditions. • Can reduce odours from animal manures, particularly in built up or crowded areas. 	<p>Disadvantages</p> <ul style="list-style-type: none"> • Strong technical skill is required to ensure gas-tight construction as the design and construction needs to be properly sealed and waterproofed. • In case of leakage, the underground digester makes repair work difficult. • Concerns with feedstock availability being the limiting factor and the lack of a large and consistent feedstock volume within a community could hinder its adoption. • Government or other agency support is usually required to initiate and finance community biogas projects. • Capacity to operate and maintain the system can be challenging given the household or community nature of the infrastructure.

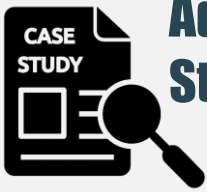

Advanced Waste Technology Examples / Case Studies

A requirement for thermal technologies to pass the fatal flaw analysis was technology maturity, showing that it has been commercially proven. Some case studies are provided below showing current plants using this advanced WTE technology as well as a range of vendors supplying this technology. The selected case studies are not in any way endorsing or advertising the vendors below but are presented to simply show a selection of what is readily available on the market.

Combustion Examples

There is a significant amount of combustion technologies on the market, either as early development technologies or established as global case studies. Frontline Waste has developed a WTE combustion system, the Gen-H System. Different to its JF System which uses pyrolysis technology, their Gen-H System uses combustion. It is a containerised modular unit, operating at extreme temperatures, with the company claiming no process emissions. The Gen-H System consists of a fluidised bed combustor, with controlled feeding at high to ultra-high operating temperatures (850°C to 1300°C). Its main product is heat, which can then be coupled with Frontline Waste's Gen-E System. The Gen-E System is a mobile organic Rankine cycle power generator. The Gen-E System converts the heat from the Gen-H System into carbon-free electricity, where one Gen-H System generates enough heat to supply two Gen-E Systems.

The Gen-H System is a small-scale technology, available to process smaller quantities of feed, of only 10 to 20 tonnes per day. Additionally, the Gen-H System has a reasonably small footprint, with dimensions of L x W x H: 8.5 m x 2.4 m x 3.6 m and weighing 26 tonnes. Similarly, the associated Gen-E System has a footprint of L x W x H: 12 m x 2.4 m x 2.9 m and weighs 19 tonnes. Both systems are mobile, with the company claiming that they can easily be transported by road, making it an option for geographically spread small facilities.

The Gen-H System does not require any pre-treatment drying, with the Original Equipment Manufacturer (OEM) reporting that extreme operating temperatures allowing conversion of waste with a moisture content of up to 35%. Additionally, the OEM claims ease of operation with low operating costs, as no additional fuel source is required other than the waste feedstock.

Additionally, the OEM claims the system is designed for a single operator, with a straightforward maintenance procedure. Feedstock accepted by the Gen-H System includes combustible feedstocks such as MSW, marine debris, industrial waste, animal waste, biomass, and non-metal hospital waste. Waste size is also an important factor, however standard-sized waste does not require pre-treatment crushing, as a screw auger conveyor shreds the feedstock into small pieces prior to entering the fluidised bed combustor. Emissions controls in place include multi-cyclone separators, baghouse filters, and wet scrubbers.

The Gen-E System's organic Rankine cycle consists of a twin-screw expander with a simple and compact design, designed for unattended operation with an automated control system and remote monitoring. The OEM claims both systems are suitable for international freight, with two 40' shipping containers – one for each system, and a 20' container for the ancillary equipment (waste hopper feeder). A simple schematic of the Gen-H System is shown below in **Figure 8**.

Figure 15 Frontline Waste Gen-H Combustion Technology

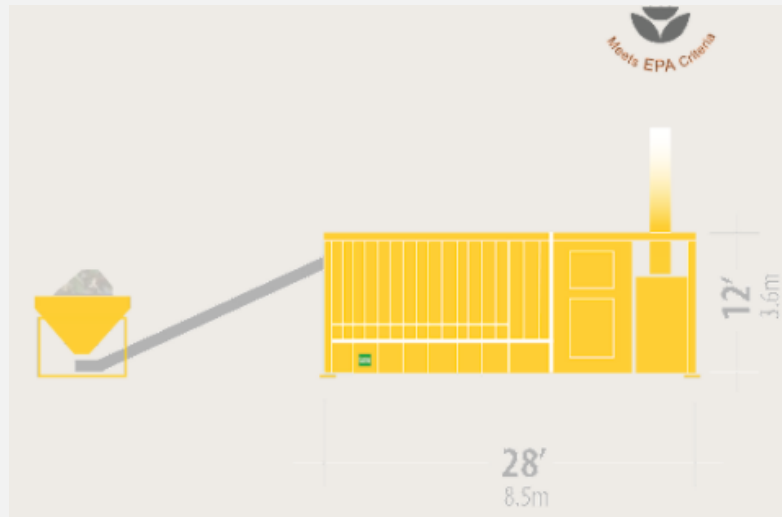

Another WTE power plant using combustion, is developed by Ecomaine. The plant opened in 1989 and is still operating daily (except for a typical two week shut down period for maintenance), processing un-recyclable waste. This translates to approximately 175,000 tonnes of waste feedstock processed annually. The plant converts the waste to electricity, at an operating temperature of 1100°C, using a moveable step grate incinerator, where waste burns for four hours, before quenching the bottom ash. Ecomaine’s plant is also self-powered, utilising the heat produced through steam and steam turbines. Ecomaine’s facility is rated to generate 14 MW, where they use only 10-15% of the electricity produced to run their two facilities and electric vehicles, sending the remaining electricity to the local grid (Ecomaine, 2021). A schematic of Ecomaine’s facility can be seen below in **Figure 9**.

Figure 16 Ecomaine’s WTE Combustion Technology

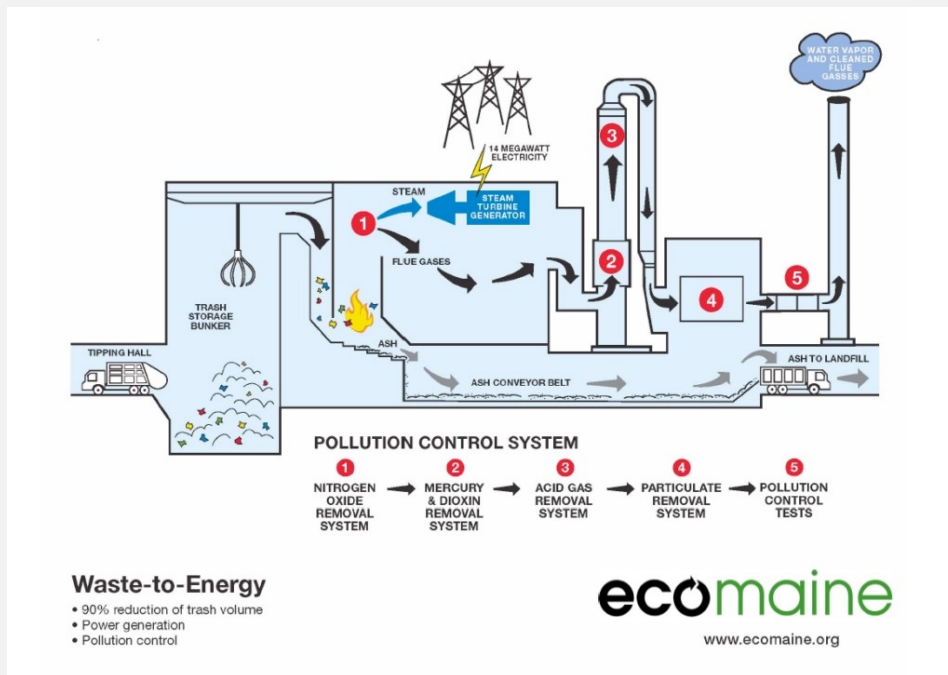

Source: Ecomaine 2021

Pyrolysis Case Studies

A small simple WTE system was developed by Nufuels Ltd, converting waste plastic bags and bottles into energy through pyrolysis. This small system was developed for use in PICs, particularly for the Solomon Islands, and has already been implemented in both Munda and Honiara. It is a small-scale unit – easy to transport and construct, therefore making it a suitable option for use in the Pacific. The system is fired typically by wood or fuel from the process. The reactor has the capacity to process 7 kg of mixed PE and PET. As shown in **Figure 17** below, the pyrolysis product gases pass through a condenser, accumulating crude in the blue container water bath, with the incondensable gases being stored in a water sealed system. The products consist of about 5 kg of viscous plastics crude and 2 kg of gases, for every 7 kg of feedstock processed.

Figure 17 Solomon Islands Small-Scale Pyrolysis Plant



Source: Blended Fuel Solutions NZ, 2021

The crude oil produced has a similar energy density to that of diesel and can be used in a ‘rocket stove’ system, allowing baking and drying whilst keeping the fuel and exhausts away from the produce. The gas produced can be used for cooking as well as used in a petrol genset (*Blended Fuel Solutions NZ, 2021*).

Another pyrolysis based advanced WTE technology available on the market is the JF System, developed by Frontline Waste. It is a simple continuous process, utilising multiple augers to transport the feedstock through a reactor, where it undergoes the thermal decomposition pyrolysis process, before exiting as biofuel. It is promoted by the OEM as an energy efficient unit, which uses its own energy output to not only power the system itself, but also dry the feedstock prior to entering the reactor. This means that no fossil fuels are required beyond ignition. The reactor is a modular unit, where the capacity can be increased by installing additional modules. Alternatively, capacity can be reduced by removing several augers from the reactor.

The OEM states that the modular unit has a small footprint, and the modules are stackable, further saving space when more capacity is required. The dimensions of the unit are: L x W x H: 6 m x 2.4 m x 2.1 m, as shown on **Figure 18** below. Frontline Waste states that their JF System is easy to install and operate, as the system can be set up in three days, and is designed to only require one operator, with easy and straightforward operation. Frontline Waste also claims the JF System has low capital costs due to its simple modular design, as well as low operating costs due to the system's self-fuelling capacity along with its capability to continue to operate during maintenance.

Figure 18 Frontline Waste Pyrolysis Technology

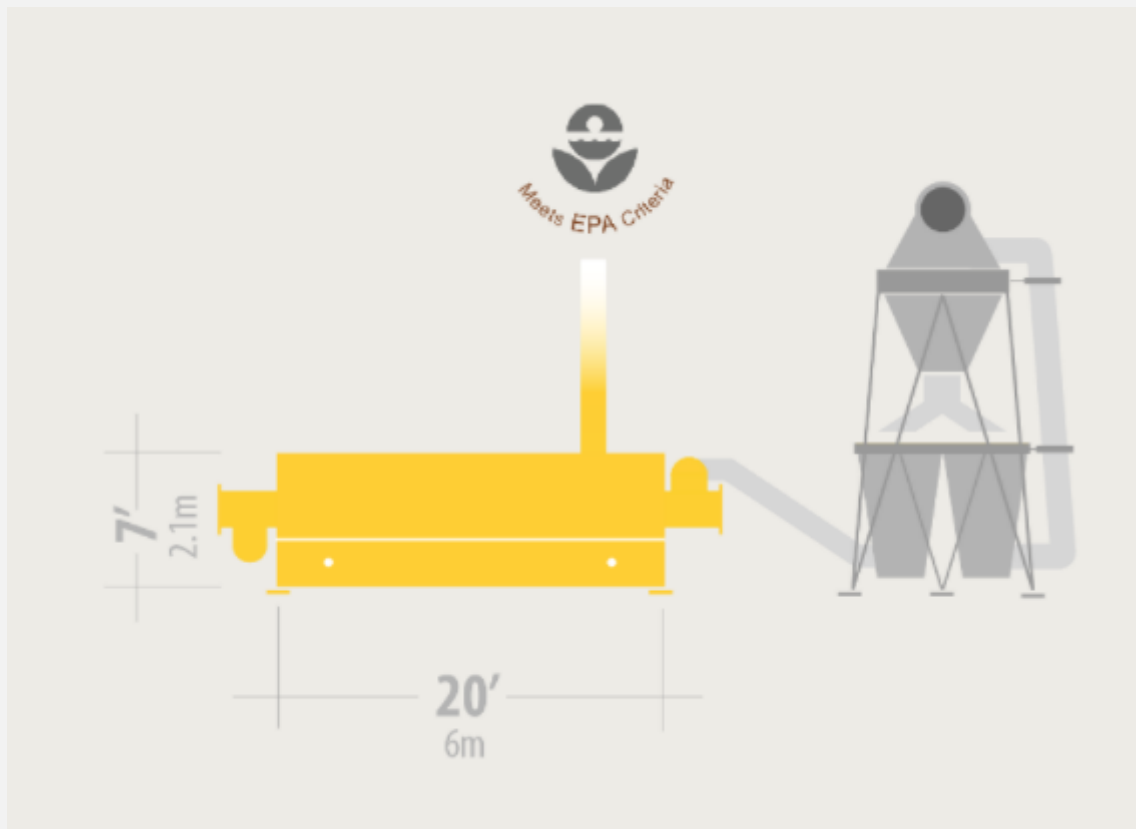

Source: Frontline Waste 2019

The system is easily transported as it fits into two shipping containers, suitable for international freight to PICs. A 40' container transports the reactor, and a 20' container transports the ancillary equipment.

The JF System uses a screw reactor, and is a continuous fed system, with a low operating temperature (although specific values were not available on their website). Products are biochar, bio-oil, and syngas, with a processing capacity of 20 to 120 tonnes per day of dry ash-free feedstock. In terms of emission controls, as this is not a combustion process, no dioxins nor ultrafine particles are produced.

The OEM of the JF System claims that it could accept a wide range of feedstock, this includes agricultural products, water plants, and municipal solid waste (MSW) including plastics, tyres, and textiles. Additionally, the OEM claims the JF System can handle any MSW composition or moisture content. As well as the JF System, Frontline Waste also supply an on-site power generator, which can be used to convert the bio-oil and syngas products to electricity. Frontline Waste states that a large JF System module can generate 5.5 MW of zero-carbon electricity from the post-recycling waste produced by 250,000 people. From a PIC perspective, the JF System could be the centre of a small-scale waste recovery facility, with feeder transfer stations spread out to easily support waste collection from smaller outer islands and atolls (*Frontline Waste 2019*).



Gasification Case Studies

In November 2020 the Government of Samoa commissioned the Afolau 750 kW biomass gasification plant with an investment of \$11.3 million tala in renewable energy transition (*Nauer 2021*). The plant uses biomass from invasive weed species and coconut logs, husks and shells to generate syngas. The gas produced is cooled then pumped into generators to produce electricity feeding into the Electric Power Corporation's grid. In the first three months since commissioning, the plant has contributed approximately 750 kilowatts per hour into the national electricity grid (*UNDP 2021*).

Figure 19 Afolau gasification plant commissioned Nov 2020



(Source UNDP 2021)

The gasification plant will utilise up to 24 tons of biomass materials each day; with an estimated feedstock of 7,000 tons per year. This will generate electricity to meet the needs of approximately 5000 households, replacing approximately 1.25 million litres of diesel imports for electricity generation.

The capital costs were funded by a grant through the Global Environment Facility, with approximately \$8.7 million for Ankur Scientific Energy Technologies Private Ltd who provided the technology and assembled the plant. Further costs included \$237,000 for local groundworks; \$877,500 for the hire of heavy machinery; \$40,000 for grid electricity connections and installation of a data system, and \$31,710 for other equipment (*Fruean 2020*).

There are a range of companies selling these types of technologies at a small to medium scale. A further example is Dynamis Energy who have developed a portable advanced thermal oxidation system for waste, named The WasteStation. This system uses dual bed indirect gasification, consisting of a gasification chamber and a combustion chamber. The OEM states that the raw MSW does not require pre-treatment, and is loaded into the gasification chamber, which is operated at relatively low temperatures, with the company claiming 90-95% destruction of the waste. The syngas produced from the gasification chamber then enters the combustion chamber, reacting with oxygen, becoming oxidised at high temperatures, and thus producing energy. This energy can then be utilised as heat or power. The company claims that the ash by-product is sterile with minimal residual carbon, although it is still an unwanted by-product, requiring disposal to landfill.

A schematic of The WasteStation can be seen below in

Figure , showing additional operating information including temperatures. The WasteStation can have one to four waste chambers within the system, catering to a variety of waste demands and populations. Each waste chamber has a loading capacity of 14 m³ per day, with the company stating that this can be combined to process up to 56 m² per day of waste feedstock.

Dynamis Energy claim simple operability, as it contains an automatic operations control panel and process logic control system – simply load the waste material into the chamber and push a button. As shown in the schematic below, it is easily transported as the system itself consists of modules that have been skid mounted and integrated into shipping containers. This provides stability for the system to travel through intense conditions often associated with freight.

Additionally, the company claims that the system has minimal construction time, and can be operating in a matter of hours. Dynamis Energy also claim their system is low maintenance due to minimal moving parts, and therefore has reduced operating costs. In addition to the operating costs, the OEM claims operational labour is only required for two to three hours per day, as it is a batch process, with loading undertaken once a day. The company claims that the WasteStation system has been tested with various feed materials including MSW, industrial waste (solids), commercial and demolition waste, medical waste, tyres, mixed plastics, and auto fluff. The OEM states that they have had their WTE technology used in operating plants since 1996 (*Dynamis Energy, 2021*).

Figure 20 WasteStation Gasification Technology

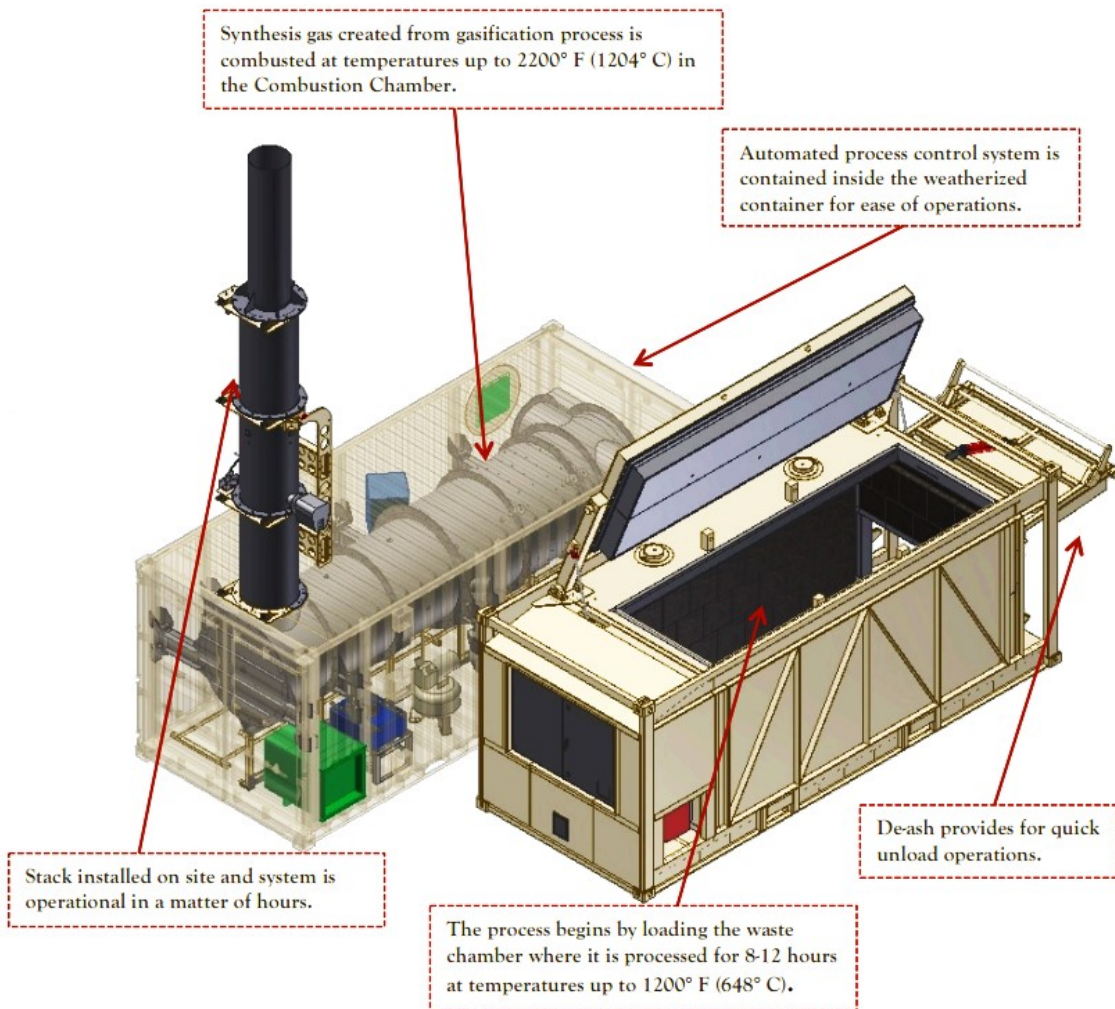

Anaerobic Digestion Case Studies

One of the key differences between different technology options is scale, with

Table 17 providing an overview of the scale in relation to feedstock and energy outputs.

Table 17 Scale of Anaerobic Reactors

Size	Feedstock Input (tonnage/year)	Energy Output	Typical Applications
Small	Up to 7,500	25 – 250 kW	Farm or household
Medium	7,500 – 30,000	250 kW – 1MW	Farm or industries with biodegradable waste

Large	30,000 or more	> 1MW	Centralised, mixed feedstock sources e.g., municipal, commercial, and industrial
--------------	----------------	-------	--

Source: Global Methane Initiative

An example of plug flow digester in use is the LARAN® plug flow digester shown below in **Figure 21**. It has been on the market for over 15 years treating municipal solid waste, kitchen leftovers, by-products from agricultural and food production, biowaste, and green waste energy crops. Plants are established in countries such as China, Poland, Germany, Spain, Netherlands, France, and Scotland (STRABAG, 2019).

Figure 21 Schematic of STRABAG Laran Plug Flow Digester

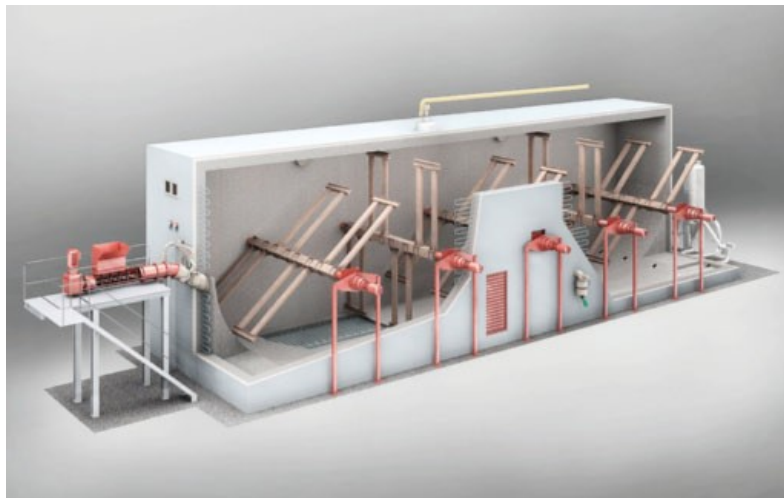

Source: STRABAG, 2019

This technology is based on the horizontal plug flow principle consisting of a horizontal vessel equipped with agitators that are arranged transversely to the flow, preventing uncontrolled sedimentation or the formation of swimming layers. The agitators are also overlapped to enhance local mixing of the material, release of gas bubbles, and movement of the treated material to the digester discharge.

The energy consumption is very low due to the intermittent agitator drive operation. Maintenance is less complex with all components such as the agitator drives, feed unit, digestate discharge and gas system easily accessible from the outside.

The STRABAG Laran Plug Flow Digester can treat dry feedstock with high levels of total solids between 15% to 50% operating under mesophilic or thermophilic temperatures. A compact feed unit feeds the input material in a semi-continuous mode, adjusting the total solids content at the same if required. Treated materials (the digestate) travels and discharges through the STRABAG vacuum discharge system. The digester is compact and robust, offering options of cast in situ or construction from prefabricated concrete elements.

A further example application of this plug flow technology is the CTR Valladolid plant in Spain that treats 200,000 tonnes/year of mixed household waste, shown below in **Figure 22**. This plant is operated by UTE Planta de Tratamiento de Valladolid and since 2001, a 15,000 tonnes/year dry STRABAG Laran Plug Flow Digester (shown in **Figure 22**) has been included to provide all energy requirements for the operation (Hagenmeyer, 2014).

Figure 22 CTR Valladolid AD Technology



Source: Hagemeyer, 2014

As the household waste is received mixed (without any source separation), screening and separation is performed prior to digester feeding. This removes any metals (ferrous and non-ferrous) and undersized fraction < 90 mm. The feedstock is estimated to still contain up to 14% inert impurities consisting of stones, ceramics, and glass. Recirculated process water is fed into the process to achieve about 40% total solids content. At the completion of the 50 days digestion period, 103.44 Nm³ biogas/tonne of feedstock is produced. Methane averaged at 65%, convertible to electricity using the plant's 780 kW electrical performance registered CHP engine.

The resultant digestate is channelled to a composting area where the impurities and rejects are removed, and the dewatered cake turned into compost in a tunnel composting facility.



Community Biodigester Case Studies

In developing economies, small-scale household anaerobic digesters are widely distributed systems in rural areas. The digesters are usually small (up to 10 m³) due to the limited amount of feedstock, which is usually contributed by the household itself and its surrounding activities. The common input materials include animal manure and by-products, kitchen or food waste, agricultural residues, and human waste.

Having a digester at a community level can greatly improve sanitation and waste management, which is often non-existent in low-income communities. Biogas produced from these small-scale reactors is usually used in situ for domestic cooking and lighting. These household or community biogas reactors are usually enabled due to contributions from various international and local donors, with government agencies overlooking monetary, planning, design, building and maintenance aspects.

Some of the widely used community biogas reactors are the fixed dome, the floating drum, and plug flow. The fixed dome digester shown in

Figure 23 was developed in China, with the digester placed underground and equipped with a dome-shaped roof. The biogas produced fills the dome and when pressurised, fills the inlet and outlet tanks with the slurry. The slurry returns into the digester when the accumulated biogas is released.

The floating drum biogas reactor (common in India) has a different biogas regulation feature to the fixed dome. It utilises a floating drum that moves dependent on the biogas volume, as depicted in **Figure 24**. An inverted drum is placed at the top of the digester with both the inlet and outlet pipes at the bottom of the reactor.

Lastly, the plug flow model is shown in **Figure 25**. It is more popular in South America, as it is more portable, partially buried and has a long-narrow structure. The digester is not fully buried, meaning it is more susceptible to temperature losses, and therefore requires insulation and roofing in order to retain the desired conditions.

Figure 23 Schematic of a Fixed Dome Digester

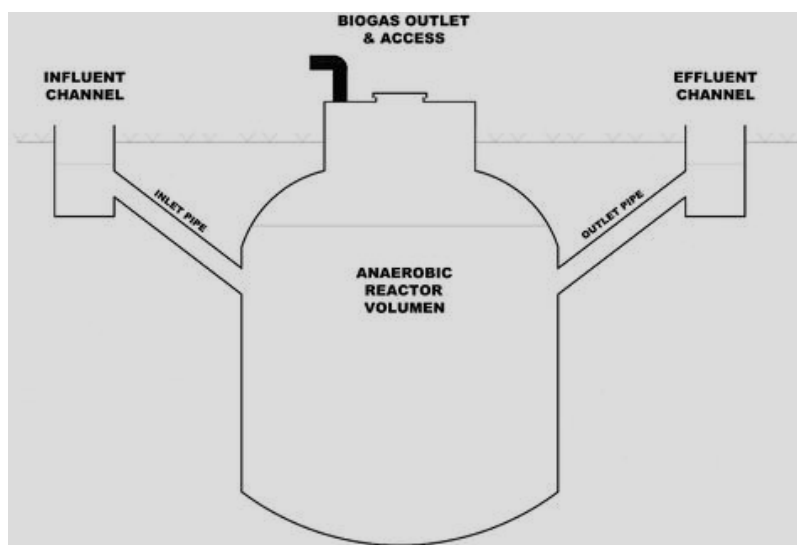

Source: Piloni and Hamed, 2021

Figure 24 Schematic of a Floating Drum Digester

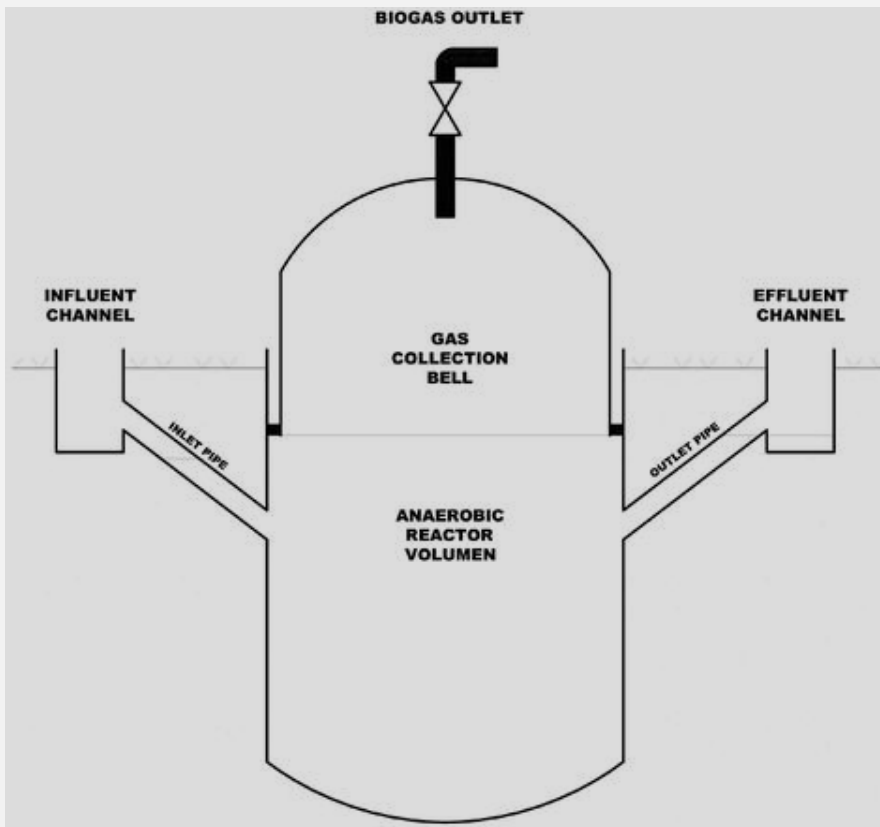

Source: Pilloni and Hamed, 2021

Figure 25 Schematic of a Plug Flow Digester

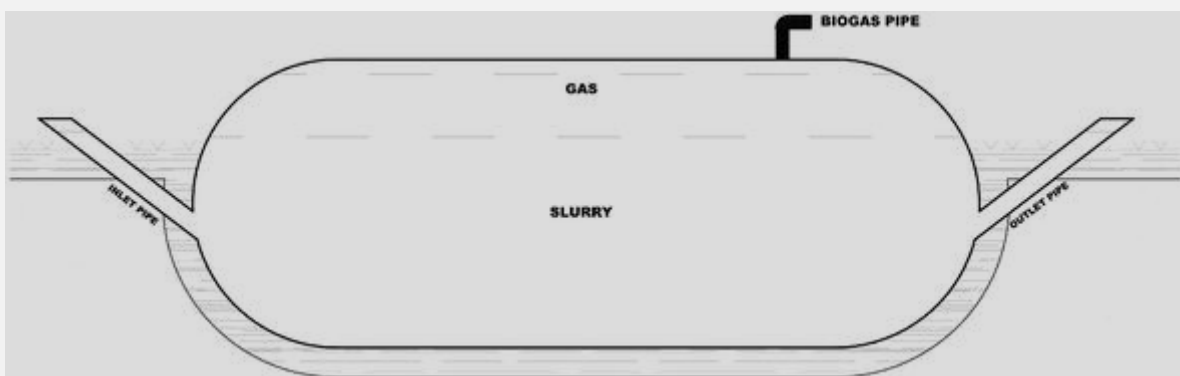

Source: Pilloni and Hamed, 2021

More than 30 million community biogas reactors are in operation in China, with over 3 million in India and hundreds of thousands in developing countries throughout Asia, Africa and Latin America (Rajendran et al., 2012). Certain Pacific Island Countries have also trialled and implemented this technology.

The biogas reactor in Vaitele, Samoa is an example of community scale anaerobic digestion in the Pacific. The reactor depicted in **Figure 26** is from BioEnceptionz and is designed to treat household sewage, food waste and other green waste.

Figure 26 Community Biogas Reactor in Samoa – Site Preparation, Tank Modules, Biodigestion Bags, Gas Equipment



Source Ward and Rucks, 2013

The biodigester installation is a demonstration project for alternative septic systems based on biodigestion as a means of improving sanitation and reducing environmental pollution from this diffuse source, a common issue in the Pacific. The demonstration in Vaitele provides a potential path forward to address sanitation issues in its residential areas, with plans to further implement this technology in other areas of Samoa, addressing all areas of poor sanitation, proving to be a significant investment. Samoa continues to invest in bio-digestion, with a biogas system to be established in Sa’asa’ai community at a cost of \$98,000 through the Global Environment Facility and United Nations Development Programme. This system will utilise piggery and cow waste, combined with household food waste to generate biogas for cooking and lighting. This is a pilot project to further explore community energy projects. The second case study relevant to the Pacific Islands is the biogas project instigated in Tuvalu, where 40 households from six remote islands were allocated a household biodigester. As a low-lying atoll nation, Tuvalu is extremely vulnerable to the impacts of climate change. With high energy costs and lack of fuel wood supplies, the biogas project aims to provide households with low-cost energy, whilst demonstrating a commitment to renewable energy.

The design is based on the floating drum digester (**Figure 24**), with a PVC-base and an inverted floating tank. Training was provided to all participants, including operations and maintenance, which was viewed as a critical success factor (Kua, 2018). Participants reported that it was beneficial and has resulted in direct savings in cooking fuel expenditure (Pacific Community, 2018). Key lessons reported were that adequate time needs to be factored in for consultation and training, with ongoing support available to participants to trouble shoot issues over time.

Feasibility Considerations for the Pacific Islands

Fit with Waste Management Hierarchy

As identified in the Cleaner Pacific 2025, the waste management hierarchy, capturing the principles of reduce, reuse, and recycle is a core foundation for waste management in the Pacific.

The first guiding principle of the Strategy is:

Reduce, Reuse, Recycle, Return (3R + Return)

In prescribing waste management interventions, the preference shall be to reduce the generation of waste and pollutants; to reuse if appropriate and safe to do so; to recycle domestically when technically and economically feasible; and to return waste resources to appropriate recycling facilities in other countries. Residual waste that cannot be reused, recycled, or returned for recycling shall be disposed of in an environmentally sound manner.

This principle is reiterated in several national policy and strategy documents, recognising that measures to avoid waste generation, then reuse and recycle are the basis of sustainable waste practices. In the Pacific region and Timor-Leste, the return principle is also appropriate given that often waste cannot be recycled in-country due to economy of scale. Several countries in the region are exploring opportunities to fund return schemes, such as end-of-life disposal levies applied at import.

There are four Strategic Goals in Cleaner Pacific 2025, with the first focused on waste and pollution prevention, and the second on resource recovery. The third goal is -

Improve management of residuals

Wastes, chemicals, and pollutants from which resources cannot be recovered require appropriate storage, collection, treatment, and disposal to minimise the risks to human health and the environment.

The fourth Strategic Goal focuses on improved environmental monitoring. Advanced waste technologies fit with the principle of disposal in an environmentally sound manner, and the Strategic Goal of improving the management of residuals. Whilst WTE is utilising waste materials as a resource, this must be considered within the lens of the broader waste management hierarchy.

For example, a WTE technology may effectively utilise resources such as plastics to produce energy, which may be more sustainable than processing and transporting overseas for recycling. However, a local plant producing building blocks that utilise plastics as an input material may provide a more valuable use of the resource. The important aspect to consider is whether the WTE technology effectively locks out future innovations.

Advanced waste technologies provide an opportunity to reduce the need for landfill, keeping in mind that there often remains a need for landfill of materials such as ash. As an alternative residual waste strategy, there are several merits, but it is important that the technology does not displace efforts to reduce, reuse and recycle.

Availability of Feedstock and Sustaining Supply

Between 2019 and 2021, the Pacific Region Infrastructure Facility (PRIF), SPREP, and other agencies used the PRIF standard Waste Audit Methodology to conduct waste audits in 14 Pacific countries and Timor-Leste. This provides an improved basis for data within the region, with a standard methodology applicable for ongoing waste composition analysis. Sound data for infrastructure and service planning is a fundamental requirement for improved waste management. This builds on earlier work undertaken by PRIF, producing a solid waste management and recycling profile for each of the Pacific countries and territories, taking into account material inflows at the border (*PRIF 2018*).

It is critical as a part of the feasibility work for any advanced waste technology, to gain a detailed understanding of available feedstock, including the source locations, and the associated waste collection systems.

A particular catchment area to feed into a WTE facility must consider the following details:

- waste composition – amounts and classification into waste types
- any seasonal variation
- current waste collection systems and if this requires expansion
- options for source segregation or segregation requirements once feedstock arrives at the plant

Organic waste makes up 53-56% of MSW in low and lower-middle income countries, yielding a low calorific value for WTE facilities (*UNEP 2019*). Countries need to consider organic fraction given that incineration requires an average calorific value of 7 MJ/kg to enable combustion without auxiliary fuel. In countries with high organic waste composition, biological treatment systems may present a better option. The waste composition is an important basis for technology selection.

If a technology requires a minimum feedstock that is over the current waste generation amount for the catchment area, this should be viewed as a fatal flaw. The analysis must also look at broader trends and make informed estimates of future waste generation. This must consider not only population growth or decline, but also the intersection with other policy initiatives such as a proposed ban on the import of single use plastics.

A further option to consider is the import of additional feedstock from outside the given waste generation catchment. However, this needs to carefully consider transport costs, and the sustainability of this supply.

For example, a wastewater treatment plant may produce a sludge, and with no local options available, may seek to transport this for disposal at a WTE facility. However, the long transport distance may instigate the development of a local bio-solids reuse project to provide a more cost-effective way to utilise the resource.

A further consideration is the risk of transporting waste. If the proposal is a shared facility between countries, the transboundary movement of waste becomes a legal constraint for signatories to the Waigani and/or Basel Conventions. These conventions are based on a principle of informed consent, ensuring recipient countries are aware of the risks of any waste materials to be brought in. The conventions provide countries with some protections against becoming 'dumping grounds' for another country. There remains potential for inequitable burdens, with the country hosting a waste (or recycling) facility effectively taking the risk from participating countries.

A very poor outcome is a technology that requires a minimum feedstock that consumes all the waste being produced, and ideally needs a growing feedstock for the right economy of scale.

In this situation, the technology provides a very real disincentive to reduce waste generation or to reuse and recycle resources. Whilst there may be an energy resource produced, it remains a resource intensive method of waste management that risks removing options that are better from an environmental and local economy perspective.

Sustaining supply is a core consideration for detailed feasibility work. Decisions must be made based on sound waste data and conservative projections about future waste generation, both quantities and composition. Countries should

avoid put-or-pay contracts, as well as long-term contracts that lock them into decades of burning waste that could have been avoided, reused, or recycled.

Scalability

Feedstock requirements leads into the critical aspect of scale. Each advanced waste technology is developed at a particular scale. Several systems are modular, providing the opportunity to start operations at a smaller scale than the available feedstock, and expand the processing line as required. Other technologies are fixed in their scale and need to be carefully matched to the available feedstocks. Modular systems that can be scaled up and down in line with changes to feedstocks over time, provide a flexible option that can have significant benefits.

Environmental Risks

Environmental risks are a further key consideration in any detailed feasibility assessment of a particular technology type.

Combustion of materials such as plastic has the potential to release toxic pollutants, including mercury, lead and dioxins. Of particular concern are dioxins known as 'persistent organic pollutants' because they resist breaking down and accumulate in animals and the environment. Dioxins can also be present in post-combustion ash waste (*Environmental Justice Australia 2021*), along with the potential risk of dioxins and furans present in air discharges if the pollution control standards are inadequate.

WTE facility emissions are directly influenced by the quality (or potential hazards) within feedstocks, the design of the facility (particularly the pollution control technologies), and the operational practices (*Cole-Hunter et al 2020*). Choosing technology with an appropriate level of pollution control is an essential consideration.

A further environmental challenge is that many small island states are vulnerable to natural disasters or extreme weather events. This increases operational risk, with facilities vulnerable to damage not only from the day-to-day high wear of coastal environments, but from damage during cyclones, storm surges, or other natural disasters. In low-lying atolls, vulnerability to predicted sea level rise exacerbates these risks. Natural disasters also produce surges in waste quantities, requiring consideration of storage capacity for any waste facility.

Landfilling of incineration residues is a further risk to be considered, with the potential for contamination of freshwater resources another risk to be managed. In Bermuda, bottom ash from a thermal WTE plant was utilised as a material in concrete blocks (after recyclable ferrous and non-ferrous metals were removed), which were then used to create an artificial reef. However, in using bottom ash in an offshore reclamation area, there was evidence of sediment and reef contamination with furans, dioxins, and other hazardous chemicals (*Jones 2009*). In many places, bottom ash is used as a material in road construction, but this may not be an option in countries with limited road construction opportunities.

Gender and Social Inclusion

There are several social aspects that are key to improving waste systems in a way that does not create inequitable outcomes or community division. Stakeholder engagement is essential, with meaningful engagement as a part of the feasibility assessment process. This will provide the opportunity to hear concerns and ensure they are addressed throughout the process. Public opposition to the installation of an advanced waste technology facility is often a major obstacle, and as such, attaining social licence is essential. This occurs through providing clear evidence-based information, opportunities for dialogue, and transparent decision-making processes.

Stakeholder mapping is a key step to understand the potentially affected groups and communities. This will form the basis for any compensatory strategies to ensure that no one is worse off from the development.

Gender considerations are key to the analysis. For example, if the technology is presenting more risk to pregnant women due to potential for air emissions if the facility is not operated as per the design. Risks must be clearly articulated and explored to ensure that unfair burdens do not occur.

There must be consideration applied to economic displacement. For example, in many places, the work of waste-pickers identifying, sorting, and on-selling resources is largely undertaken by people who are socially disadvantaged. Workers are often already poor and losing this livelihood option may worsen their situation. Consideration needs to be given to providing alternative and safe options for livelihoods.

The siting of the facility must consider close neighbours and communities, and potential impacts. Waste facilities of any kind are typically difficult to site with adequate buffers and environmental safeguards. However, it is a priority to consider social equity aspects, and ensure that those who already have disadvantage do not have this compounded by the choice of site for the new facility. Ideally, the advanced waste technology would be sited within an existing landfill site, but this will still need to consider existing neighbours, who are often poor communities or people facing social disadvantage.

The final aspect to consider is on the side of opportunities. Advanced waste technologies provide employment, often requiring significant technical training and support. Technical roles are often provided to men in PICs as a default, despite the evidence from sectors such as mining and energy that gender balance can improve productivity and safety. It is recommended that training and employment opportunities are considered for both women and men during the planning and implementation phases.

Further Constraints

The legal and policy framework is an important mechanism to reduce the risks from advanced waste technologies. PICs may lack legislation on internationally recognised emission standards, providing inadequate protections. The capacity for monitoring and enforcement is the secondary essential element of regulatory oversight. Without effective monitoring and reporting, environmental and health risks cannot be effectively managed.

PESTLE Analysis

The following high-level PESTLE analysis (Political, Environmental, Social, Technological, Legal, and Economic) is provided as an initial guiding assessment. Countries considering investment in WTE are encouraged to undertake a more detailed assessment. The PacWastePlus Programme has developed an MS Excel based PESTLE Decision Support Tool available from the Programme website (www.pacwasteplus.org)

Table 18 PESTLE Analysis of Advanced Waste Technologies

	Pyrolysis	Gasification	Combustion	Co-digestion	Plug Flow Anaerobic Digestion	Small Scale Biodigesters
Political						
Political Drivers	Any of these options may be supported politically if it can demonstrate tangible benefit to the people. This will include considerations of affordability, which can be problematic in areas with no user fees for poor waste services, as willingness to pay may be low, which risks becoming a political debate. Political will to resolve waste management issues is a pre-requisite for change, with waste gradually being seen as a more pressing issue in the Pacific.					
Consultation with Government Stakeholders	This is a pre-requisite for implementation of any advanced waste technology, as it will need support across sectors, including waste, energy, and agriculture. It will also require consultation across the planning, infrastructure, and financial sectors, and be prioritised in national infrastructure investment planning.					
Media Attention	There is a risk that negative media attention can draw criticism or politicise technology choice. Transparent and open communication from the start is required to minimise this risk, ensuring that accurate information is provided to the media.					
Governance Arrangements	Governance arrangements are fundamental to investing in advanced waste technologies. The roles of operator and regulator need to be clearly articulated. If the facility is a public private partnership, support for establishing and managing transparent and effective contracts will provide the best results for the Government and the community, whilst avoiding politicisation of roles. Ongoing communication of risks and mitigation are an essential component of sound governance.					
Environmental						
Human Health	Effects on human health were considered and pyrolysis, gasification and combustion technologies were found to have the potential of negatively affecting the operator's health, if there were an accident / explosion. There is also the potential for health impacts from air pollution, particularly from combustion technologies.			There are limited risks to human health from AD.		There are limited risks to human health from biodigesters, provided they are constructed well, and are maintained to avoid leakage, particularly if household sanitation waste is being treated.
Pollution (Air, Water, Or Land)	Pollution effects have been considered and pyrolysis was found to have very minimal effects to all land, air, and water environments, due to the high conversion efficiency of the waste feedstock, along with the pollution controls in place. The same applies to gasification technologies. For combustion, pollution control components must meet relevant standards to ensure release of dioxins and other toxins are avoided. Monitoring is also essential.			There are limited environmental risks provided the facility is not releasing leachate. Facilities are enclosed to avoid air pollution or odour.		As above.

	Pyrolysis	Gasification	Combustion	Co-digestion	Plug Flow Anaerobic Digestion	Small Scale Biodigesters
Visual Amenity	Protection of visual amenity is dependent on scale of the facility and siting. This must be carefully managed to avoid impacts.				Leachate and sludge may contain micro-plastics and need suitable end use. AD facilities are enclosed and can be screened to protect visual amenity.	Limited risk as they are usually buried in the ground and sited away from high amenity areas.
Noise	All thermal technologies have noise emissions particularly in the pre-treatment of waste (e.g., grinding). Enclosed facilities and siting away from sensitive receptors are critical to avoid impacts.				AD facilities are enclosed to minimise noise and sited away from sensitive receptors.	No noise emissions.
Traffic	Traffic impacts will depend on the scale of the facility, and the siting. This will need to be addressed in the EIA process.					No traffic impacts.
Climate Change	All technologies are mitigation measures, reducing GHG emissions from landfilling, and utilising the waste resource to produce a renewable energy to replace fossil fuel-based energy sources.					
Local Natural Resources	No impact on local resources. If biomass is to be included as a feedstock, it needs to be from waste products.					
Local Flora and Fauna	Impact would only occur due to poor siting in an area with rich biodiversity. This will be assessed as a component of the EIA.					No impact.
Local Ecosystems	As above.					No impact.
Energy	All technologies produce a form of energy. However, energy inputs need to be considered as part of the feasibility work.					Produces local source of sustainable energy at household or community scale.
Land Use and Aquaculture	Impacts related to siting and potential loss of agricultural land, or conflicts with other land uses such as tourism. This will need to be considered in the EIA.					Unlikely to have any impact.
Natural Hazards	Natural hazards must be considered as a component of detailed feasibility work and siting. Sea level rise and increasing natural disasters are a significant risk for facilities. Design and construction must take this into account.					Limited risk as construction is within the ground.
Environmental Targets	All advanced waste technologies align with renewable energy targets, with varying impacts depending on the technology energy outputs and scale. An important consideration is how the proposed technology aligns with any waste avoidance, reuse, or recycling targets. There is a risk that some thermal technologies with minimum feedstock requirements may provide a disincentive for the 3Rs.					

	Pyrolysis	Gasification	Combustion	Co-digestion	Plug Flow Anaerobic Digestion	Small Scale Biodigesters
Social						
Consultation with Community Groups	Social licence is critical, particularly with thermal technologies, where there may be fears of health or pollution impacts. Consultation from the outset is critical, ensuring stakeholders understand the challenges, and constraints. For small-scale biodigestion, the community and or recipients need to be willing participants, and understand the work involved.					
Community Suitability or Applicability	This is a risk with all advanced waste technologies, with some potentially viewed as incompatible with current community priorities. Any increased costs must be discussed, without over-stating the financial returns from energy sale. The proposed technology needs to be viewed as an appropriate solution.					Attitudes need to be understood, as the technology will fail if it is not culturally favoured.
Cultural Heritage and Local Traditions	Unlikely to have impact, but siting must consider cultural heritage as part of the EIA process.					Impacts unlikely, although any cultural barriers must be openly discussed.
Technological						
Fit for Purpose	Being fit for purpose is a core aspect of the detailed feasibility assessment. There will be a number of options, and technologies available, but fit for purpose must inform decision making. Having successful plants in similar settings is an advantage and fit for the feedstock readily available must be ensured.					
Build and Installation	These technologies will be internationally sourced. Those that come in modular or containerised systems should be viewed favourably. Technical support for build, operate (initially) and maintain functions need to be explored. Installation must consider the harsh coastal environment, and the need for protection from the elements.					Simple to build using local labour.
Operation and Maintenance	Operation and maintenance are a risk given limited local capacity in a number of PacWastePlus countries. As such, the contract model must consider initial operations and long-term maintenance contracts as a core component of sustainability. This is the case for many donor funded equipment installations over relatively short term project lifespans, and the lesson consistently learned is that operation and maintenance is a fundamental sustainability issue.					Training must be provided, or longer-term support.
Upgrades	Upgrades are an unlikely aspect of these technologies, as the aim would be to gain utilisation of the infrastructure over the projected life of the asset. Minor upgrades, such as improved pollution control additions may be possible, but upgrades are generally not considered likely. This is another reason why the feasibility work must be undertaken with rigour.					
Decommissioning	All options must consider decommissioning as a part of the feasibility process. Importantly, thermal processes still require landfill for disposal of ash, and AD processes will still need landfill for residuals from the inorganic fraction of the waste. The planning for longer term operations and decommissioning are an essential component of planning.					Decommissioning is a consideration, but not viewed as a significant risk.
Legal						

	Pyrolysis	Gasification	Combustion	Co-digestion	Plug Flow Anaerobic Digestion	Small Scale Biodigesters
Legislations, Regulations and Policies	A key risk for advanced waste technologies is adequacy of regulatory oversight. Emission monitoring needs to be built into contracts, with regular reporting to national ministries with the mandate for environmental protection. The technology must be aligned with national policies, including commitments to renewable energy, and to waste reduction, reuse, and recycling.					Need to ensure the building code and planning regulations are open to bio-generators, and that pollution control legislation is considered.
Other Countries	The Waigani and Basel Conventions must be considered if there is any transboundary transport of waste (although this is considered unlikely unless for hazardous wastes).					Not applicable.
Economic						
Commercial Viability	Advanced waste technologies are developed through public private partnerships, which will require commercial viability through disposal fees and energy revenue. Viability may not be a core consideration of technology feasibility assessment but will be the core aspect once the step of Expressions of Interest and tendering for partners is undertaken. Any partnership will need to closely consider viability, balanced with affordability for communities.					At a small-scale level, this is not so much a commercial consideration, but one of reducing household or community costs.
Cost-Benefit Analysis	A cost benefit analysis is relevant for all advanced waste technologies. This will consider the drivers for change, the benefits (including environmental and social), and the costs. Given the long-term application of this type of investment, cost-benefit analysis will need to provide clarity for decision makers, with assumptions clearly articulated.					
Other Financial Impacts	User fees required as a basis for the technology must be analysed in terms of capacity to pay, and potential unintended consequences. If waste service fees rise significantly, will this create a response of increased illegal dumping and burning due to limited capacity to pay.					
Wider Economic Benefits	Pacific Islands and Timor-Leste, to varying degrees, have vibrant tourism economies. A key threat to this is visible poor waste management, including marine plastics, illegal dumping, littering, and burning of waste. Other wider economic benefits include health and environmental benefits from improved waste management, although this must be balanced with any potential impacts to consider from the proposed advanced waste technology.					
Financial Governance	Clearly articulated contracts in any Public Private Partnership (PPP) arrangement must spell out financial governance to ensure costs are projected accurately, and communities are protected from price shocks.					Needs oversight during implementation but is best managed over the longer term as a household or community asset, providing incentives to continue to maintain and operate.

Guidance for Decision Making

All technologies need to be reviewed within each country's context, with full feasibility work to be undertaken as part of due diligence. The key steps are outlined below in **Figure 27**.

Figure 27 Considerations for Advanced Waste Technologies

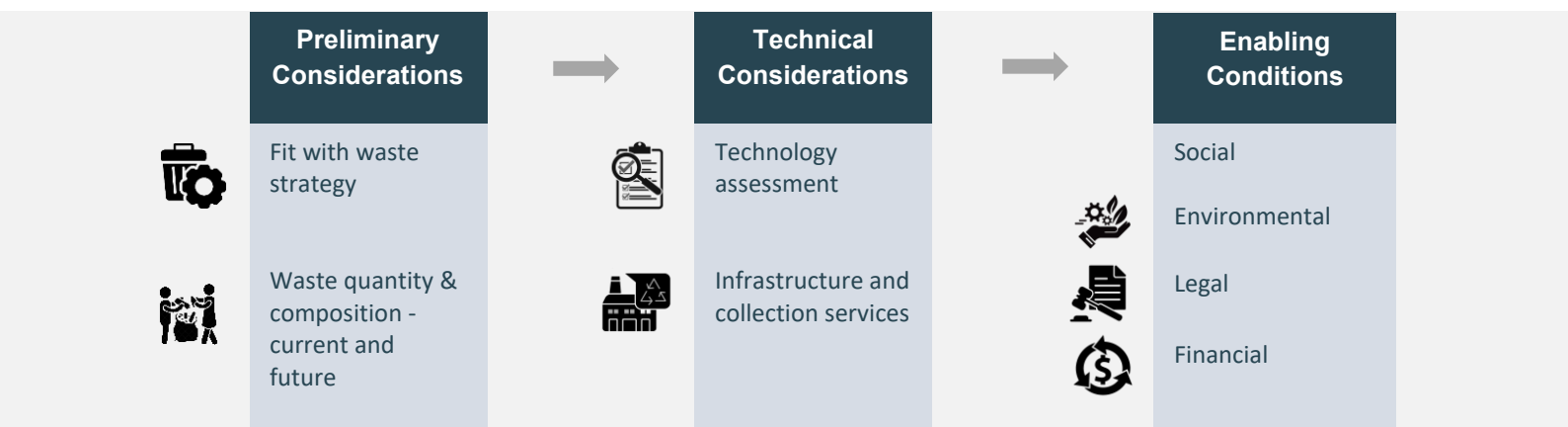

Preliminary Considerations

The first component for a country is to view advanced waste technologies within the perspective of their national waste management strategy. Understanding the unique challenges within the local context provides an important baseline. For example, the Cayman Islands selected a WTE facility due to shortage of suitable land for landfilling waste, increasing volumes of waste particularly from the tourism industry, and impacts to the tourism industry from the growing visibility of the landfill site.

Whilst the solution has increased disposal costs considerably, the drivers for change are centred on improving a system with unsustainable landfill practices in a country with limited options for new landfills (*Klein 2021*). A key driver was to develop a system that does not impact local amenity (*Amec Foster Wheeler Environment and Infrastructure 2016*).

An assessment of the current waste management system performance is required. Understanding the challenges, and prioritising outcomes that have resonance at a local level provide the foundation for selecting waste management options. The key message is that advanced waste technologies should only be considered as a part of a broader strategy to minimise and manage waste and pollution.

Once the key drivers for change are well understood, and an advanced waste technology is viewed as a sound option, there needs to be further detailed preliminary investigations, namely:

- Detailed waste characterisation data
- Waste flows – population numbers and locations, collection services, transport routes, distances, and waste composition / generation data
- Potential facility locations
- Clarity about requirements – what wastes need to be treated, and what outcomes are sought
- Demand for end-products
- Local infrastructure and waste service analysis, including areas of waste generation and transport routes

Technical Considerations

Once the feedstock and existing waste infrastructure is understood, a full technical assessment of advanced waste technology options must be undertaken.

Key considerations include:

- What technologies are suitable to the scale and composition of the waste to be treated
- The type of energy to be generated and how applicable this is at a local level, including demand
- Availability of a controlled landfill close for residual disposal such as ash and flue residues
- Requirements for the waste segregation and/or collection system
- Local capacity for regulatory oversight

The technology analysis must be based on an 'agnostic' viewpoint. For example, in countries where the organic waste fraction is large, alternative WTE technologies such as anaerobic digestion could be more effective than thermal WTE for treating waste. A holistic assessment of all WTE options should always be undertaken, aligned with national waste management policy objectives.

Enabling Conditions

A life cycle assessment that includes a cost benefit analysis of thermal WTE and other potential WTE technologies would be beneficial to compare technology options, particularly costs. The social, economic, and environmental impacts and co-benefits of a WTE plant throughout its life cycle should be considered.

Siting of the proposed facility is also a critical aspect, ensuring that a full Environmental Impact Assessment provides a clear assessment of alternatives. The EIA must also assess the GHG emissions, and the potential for impacts from emissions during operations.

The following legislative considerations must be undertaken:

- Laws that provide clarity on emissions standards, including flue gas and residual ash disposal (aligned with appropriate international standards)
- Plant decommissioning needs to be clear
- Integration of the advanced waste technology into the national waste strategy, and how it interacts with waste avoidance, reuse, and recycling

Financial aspects are an integral component of the enabling environment, considering

- Projected costs and revenues
- Analysis of costs over the life cycle of the technology
- Inclusion of additional pre-requisite costs, such as improvements to the waste collection system or implementation of source segregation

Advanced waste technologies are a large investment for developing countries. Investment sources can include:

- Donor funds
- Government subsidies
- Private sector investments
- Revenue from carbon credits
- User fees
- Energy sale revenue

In a typical PPP structure for WTE projects, the developer undertakes the development of the project under the Design-Build-Own-Operate (DBOO) model where the developer secures its own financing and builds, owns, maintains, and operates the WTE facility to meet the contracted obligations over the lifespan of the facility (KPMG 2021). In terms of sustainability, long-term maintenance contracts are likely to be a minimal requirement for technology providers, along with supporting operational functions.

The final component of the enabling environment is stakeholder acceptance. Providing opportunities for robust discussion, transparent information sharing, and collective problem solving will create a more robust enabling environment.

Without this, the technology cannot provide an effective solution to the immediate and long-term challenges of improved waste management in the Pacific Islands and Timor-Leste.

References

- ADB (2014). *Solid Waste Management in the Pacific: Appropriate Technologies*. Asian Development Bank.
- ADB (2013). *Energy in the Pacific*. Publication ARM135982-3. Asian Development Bank.
- Amec Foster Wheeler Environment & Infrastructure (2016). *Integrated Solid Waste Management System for the Cayman Islands. Consultation Draft Outline Business Case*. Retrieved from: <https://cnslibrary.com/wp-content/uploads/Consultaion-Draft-OBC-Integrated-Solid-Waste-Management-System-for-the-Cayman-Islands-September-2016.pdf>
- Blended Fuel Solutions NZ (2021). *Small scale waste to fuels in the Pacific Islands*. Retrieved from: <https://www.bfsnz.biz/pyrolysis-PI>
- Cantrell, K. B., Ducey, T., Ro, K. S., and Hunt, P. G. (2008). *Review: Livestock waste-to-bioenergy generation opportunities*. *Bioresource Technology*, 99(17), 7941-7953
- Cheng, S., et al. (2014). *Development and application of prefabricated biogas digesters in developing countries*. *Renewable and Sustainable Energy Reviews*, 34, 387-400.
- Cole-Hunter, T., et al. (2020). *The Health Impacts of Waste-to-energy Emissions: A Systematic Review of the Literature*. *Environ. Res. Lett* **15** 123006
- Dynamis Energy (2021). *The WasteStation*. Technical brochure. Retrieved from: https://f4e078a9-e31f-4e86-8d52-390b4a33c2d2.filesusr.com/ugd/9abbb3_6522d23b6ede4b7ab562db97cb624e37.pdf
- Ecomaine (2021). *Ecomaine's Waste-to-Energy Power Plant*. Retrieved from: <https://www.ecomaine.org/our-facility/waste-to-energy-plant/>
- Environment Canada (2013). *Technical Document on Municipal Solid Waste Organics Processing*. Retrieved from: https://www.canada.ca/content/dam/eccc/migration/main/gdd-mw/3e8cf6c7-f214-4ba2-a1a3-163978ee9d6e/13-047-id-458-pdf_accessible_ang_r2-reduced-20size.pdf
- Environmental Justice Australia (n.d.). *Waste to Energy: What does it mean for communities and the environment?* Retrieved from: <https://www.envirojustice.org.au/our-work/community/air-pollution/resources/waste-to-energy/>
- Frontline Waste (2019). *Waste-to-Fuel*. Retrieved from: <https://www.frontlinewaste.com/waste-to-fuel>
- Fruean, A. (2020). *Samoa commissions first biomass gasification plant*. *Samoa Observer*. Retrieved from: <https://www.samoobserver.ws/category/samoa/74408>
- Hagenmeyer, M. (2014). *Application of Anaerobic Digestion for the Treatment of Municipal Solid Waste in Several Projects in Waste management*. Vol. 4., Waste-to-energy. Neuruppin: TK.
- Howell, J. (2015). *Alternative Waste Solutions for the Pacific Region: Learning from the Hawai'i Experience*. Asia Pacific Issues No 121 November 2015. East-West Center.
- IRENA (2021). *Pacific Islands Unite Around Enhanced Renewables Ambition under Climate Goals*. Press Release February 2021. International Renewable Energy Agency. Retrieved from: <https://www.irena.org/newsroom/pressreleases/2021/Feb/Pacific-Islands-Unite-Around-Enhanced-Renewables-Ambition--Under-Climate-Goals>
- Januri, Z., Rahman, N. A., Idris, S. S., Matali, S., & Manaf, S. F. A. (2015). *Microwave Assisted Pyrolysis of Automotive Paint Sludge* in *Technology Journal* 75(8). Penerbit UTM Press. Retrieved from: https://www.researchgate.net/publication/281192409_Microwave_assisted_pyrolysis_MAPof_automotive_paint_sludge_APS
- Karki, R., et al. (2021). *Review: Anaerobic co-digestion: Current status and perspectives*. *Bioresource Technology*, 330(125001), 1-12.
- Kawasaki Heavy Ind. Ltd. (2021). *Main Characteristics of Gas Turbine and Gas Engine*. Retrieved from: http://global.kawasaki.com/en/energy/solutions/distributed_power/comparison.html

- Klein, M. (2021). *Waste-to-energy: Expensive Technology that Aims to Solve Landfill Problem*. Cayman Compass. May 2021.
- KPMG (2021). *Waste to Energy*. Green Solutions for Emerging Markets. Retrieved from: <https://home.kpmg/xx/en/home/insights/2019/10/waste-to-energy-green-solutions-for-emerging-markets.html>
- Kua, N. (2018). Tuvalu Biogas Training. Pacific Community.
- Kumar, M., Morya, R., Gupta, A., and Thakur, I. S. (2020). *Anaerobic biovalorization of pulp and paper mill waste*. *Biovalorisation of Wastes to Renewable Chemicals and Biofuels*. Chapter 3, 41-61.
- Lemonde, M. (2021). *What is the Future of Small-scale Anaerobic Digestion Plants?* Biogas World Newsletter. Published 28/05/20 and updated 12/7/21. Retrieved from: <https://www.biogasworld.com/news/future-small-scale-anaerobic-digestion/>
- Nauer, M. (2021). *New Biogas System Launched*. Samoa Observer. Retrieved from: <https://www.samoaoobserver.ws/category/samoa/81756>
- NextFuels (2013). *NextFuels introduces hydrothermal process to produce biofuels from wet, unprocessed waste; solution for palm plantation residue*. Green Car Congress. Energy, technologies, issues and policies for sustainable mobility. Retrieved from: <https://www.greencarcongress.com/2013/08/20130819-next.html>
- Pacific Community Statistics for Development Division (2020). *Population Estimates and Projections*. Statistics for Development Division. Retrieved from: <https://sdd.spc.int/topic/population-estimates-and-projections>
- Pacific Community (2018): Tuvalu Results Summary. https://spccfpstore1.blob.core.windows.net/digitalibrary-docs/files/e5/e56d6feaccb73af0bb8b1ab514e14944.pdf?sv=2015-12-11&sr=b&sig=fccnArwRY4ecu1Yyyk%2FRU1UPdZjpHB1GF6jIRCLUezo%3D&se=2022-05-07T05%3A07%3A29Z&sp=r&rsc=public%2C%20max-age%3D864000%2C%20max-stale%3D86400&rsc=application%2Fpdf&rscd=inline%3B%20filename%3D%22Tuvalu_Results_Summary_2018.pdf%22
- Pacific Region Infrastructure Facility (2018). *Solid Waste Management and Recycling: Pacific Country & Territory Profiles*. PRIF. https://www.theprif.org/sites/default/files/documents/prif_waste_book_web_0.pdf
- Paisley, M. A., Irving, J. M., Overend, R. P. (2001). *A Promising Power Option – The Ferco Silvagas™ Biomass Gasification Process – Operating experience at the Burlington Gasifier*. Proceedings of ASME Turbo Expo 2001. ASME Turbo Expo Land, Sea, & Air 2001. New Orleans, Louisiana, USA.
- Palmer, L. (2012). *The Establishment of Long Term Financing for Solid Waste Management*. CITAF Project 2012
- Piloni, M. and Hamed, T. A. (2021). *Small-Size Biogas Technology Applications for Rural Areas in the Context of Developing Countries*. *Anaerobic Digestion in Built Environments*. Intechopen Online. DOI: 10.5772/intechopen.96857
- Pinkard, B., et al. (n.d.). *Supercritical Water Gasification: Practical Design Strategies and Operational Challenges for Lab-Scale, Continuous Flow Reactors*. Mechanical Engineering Department, University of Washington, Seattle, WA 98195. Retrieved from: <https://arxiv.org/ftp/arxiv/papers/1901/1901.09466.pdf>
- Rajendran, K., Aslanzadeh, S., and Taherzadeh, M. J. (2012). *Household Biogas Digesters—A Review*. *Energies* 5(12). DOI:10.3390/en5082911
- Labatut, R. A., and Pronto, J. L. (2018). *Chapter 4 – Sustainable Waste-to-Energy Technologies: Anaerobic Digestion in Sustainable Food Waste-To-energy Systems*. Academic Press. pp. 47-67.
- Schnaars, K. (2012). What every operator should know about anaerobic digestion. Operator Essentials. Water Environment Federation. Retrieved from: <https://www.wef.org/globalassets/assets-wef/direct-download-library/public/operator-essentials/wet-operator-essentials---anaerobic-digestion---dec12.pdf>
- Singh, S. P., & Prerna, P. (2009). *Review of recent advances in anaerobic packed-bed biogas reactors* in *Renewable and Sustainable Energy Reviews*. 13(6-7), 1569-1575

- Singh, P., et al. (2020). *An Overview of the Technological Applicability of Plasma Gasification Process in Contemporary Environmental Issues and Challenges in Era of Climate Change*. Pp 261-275. Springer, Singapore. Retrieved from:
https://doi.org/10.1007/978-981-32-9595-7_15
- Sivaprasad, S., Manandhar, A., & Shah, A. (2021). Hydrothermal Carbonization: Upgrading Waste Biomass to Char. CFAES, Ohioline. Ohio State University. Retrieved from:
<https://ohioline.osu.edu/factsheet/fabe-6622>
- SPREP (2021). *Waste Legislative Review: Regional Solutions Assessment*. PacWastePlus. Apia, Samoa.
- SPREP (2020). *Indicator 27 of 31 in State of Environment and Conservation in the Pacific Islands: 2020 Regional Report*. SPREP. Apia, Samoa.
- SPREP (2016). *Cleaner Pacific 2025: Pacific Regional Waste and Pollution Management Strategy 2016- 2025*. SPREP. Apia, Samoa.
- SPREP (2018). *Practical Guide to Solid Waste Management in Pacific Island Countries and Territories*. SPREP. Apia, Samoa.
- STRABAG (2019). *Project Data List Status*. Completed Projects Plant Engineering, References Biogas Plants. Retrieved from:
[https://www.strabag-umwelttechnik.com/databases/internet/_public/files.nsf/SearchView/CCB845B1B7EADDE7C12584B9003C3DCB/\\$File/190520_Refliste_Biogas_d.pdf](https://www.strabag-umwelttechnik.com/databases/internet/_public/files.nsf/SearchView/CCB845B1B7EADDE7C12584B9003C3DCB/$File/190520_Refliste_Biogas_d.pdf)
- Stringfellow, T. (2014). *An Independent Engineering Evaluation of Waste-to-Energy Technologies*. Renewable Energy World. Retrieved from:
<https://www.renewableenergyworld.com/baseload/an-independent-engineering-evaluation-of-waste-to-energy-technologies/>
- Tilley, E., Ulrich, L., Luethi, C., Reymond, P., Zurbruegg, C. (2014). *Compendium of Sanitation Systems and Technologies*. 2nd Revised Edition. Duebendorf, Switzerland: Swiss Federal Institute of Aquatic Science and Technology (Eawag)
- United Nations Development Programme (2021). *From a high school teacher to a biomass gas plant operator*. June 30 2021. UNDP Samoa. Retrieved from:
<https://undpsamoa.medium.com/from-a-high-school-teacher-to-a-biomass-gas-plant-operator-1b5484119da1>
- Tassew, F. A., Bergland, W. H., Dinamarca, C., Kommedal, R., & Bakke, R. (2019). *Granular Sludge Bed Processes in Anaerobic Digestion of Particle-Rich Substrates*. Review. *Energies*, 12(2940).
- United Nations Environment Programme (2019). *Waste-to-Energy: Considerations for Informed Decision-Making*. Retrieved from:
<https://www.unep.org/ietc/resources/publication/waste-energy-considerations-informed-decision-making>
- Vandevivere, P., Baere, L. D., & Verstraete, W. (2002). *Types of anaerobic digesters for solid wastes in Biomethanization of the organic fraction of municipal solid wastes*, J. Mata-Alvarez, Ed. IWA Publishing, 2003, pp. 111–140.
- Wander, A., Sagapolutele, F., Foxe, A., Prince, A. (2019). *Solomon Islands – Waste Data Report*. Centre for Environment, Fisheries & Aquaculture Science. Suffolk UK.
- Wander, A., Sagapolutele, F., Prince, A., & Thompson, G. (2021). *Tuvalu - Waste Audit Report. Consultants' Final Report*. Pacific Region Infrastructure Facility.
- Ward, M., & Rucks, B. (2013). *Feasibility Study For Biogas In Peri-Urban Area Of Vaitele In Apia Samoa*. For the Samoa Ministry of Natural Resources and Environment. Retrieved from:
<http://prdrse4all.spc.int/content/feasibility-study-biogas-peri-urban-area-vaitele>
- World Bank (2021). *The World Bank in Pacific Islands*. Retrieved from:
<https://www.worldbank.org/en/country/pacificislands/overview#1>
- Zafar, S. (2020). *Biomass Pyrolysis Process*. BioEnergy Consult. Powering a Greener Future. Retrieved from:
<https://www.bioenergyconsult.com/tag/uses-of-bio-oil/>

Appendix A - Technical Details of Fatally Flawed Options

Hydrothermal Treatment

Hydrothermal treatment is the decomposition of material through both water and heat. It consists of three main types of reactions occurring under elevated temperatures and pressures –

- hydrolysis – reaction of organic molecules with water molecules,
- dehydration – removal of water, and
- decarboxylation – removal of carboxyl groups, releasing carbon dioxide.

There are three types of thermal decomposition, these are:

- hydrothermal carbonisation (HTC),
- hydrothermal liquefaction (HTL), and
- hydrothermal gasification (HTG).

Hydrothermal Carbonisation

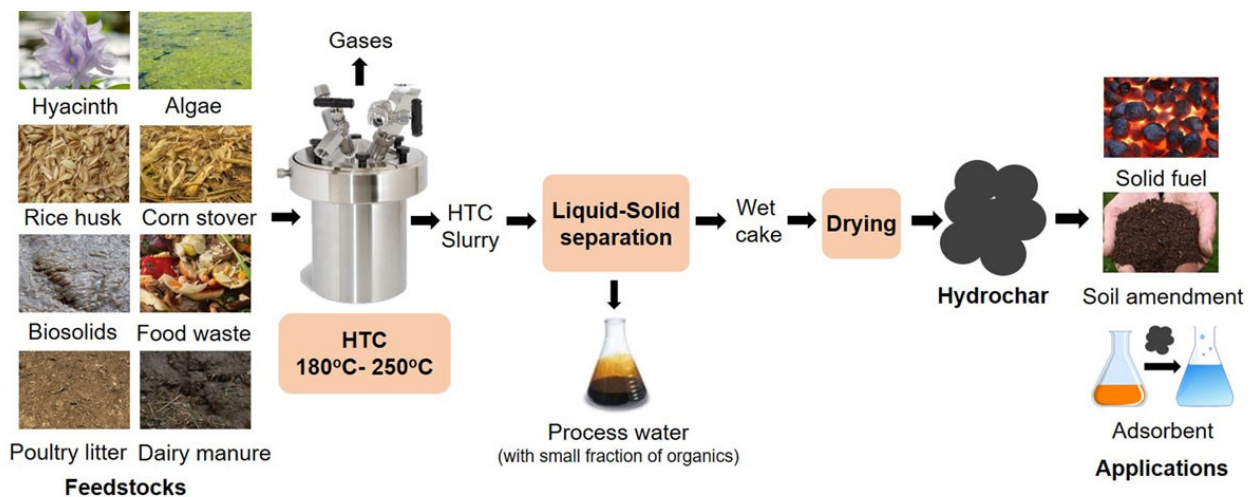

Treatment Concept

HTC has the lowest operating temperature of the three hydrothermal technology types, operating at about 180°C to 250°C and is operated at elevated pressures between 10 bar and 65 bar. HTC includes the dehydration reaction, which is where the chemically bound oxygen is removed from the biomass, resulting in the remaining carbon contained within the biomass; this is called biochar.

Common applications

Sewage sludge, wet municipal waste (such as household organics made into a slurry).

Products and by-products

HTC produces a solid biochar, with a similar calorific value to that of a low value coal.

Energy production

The biochar can be used as solid fuel in either combustion or gasification. Alternatively, it can also be used to enhance soil quality as a fertiliser.

Hydrothermal Liquefaction

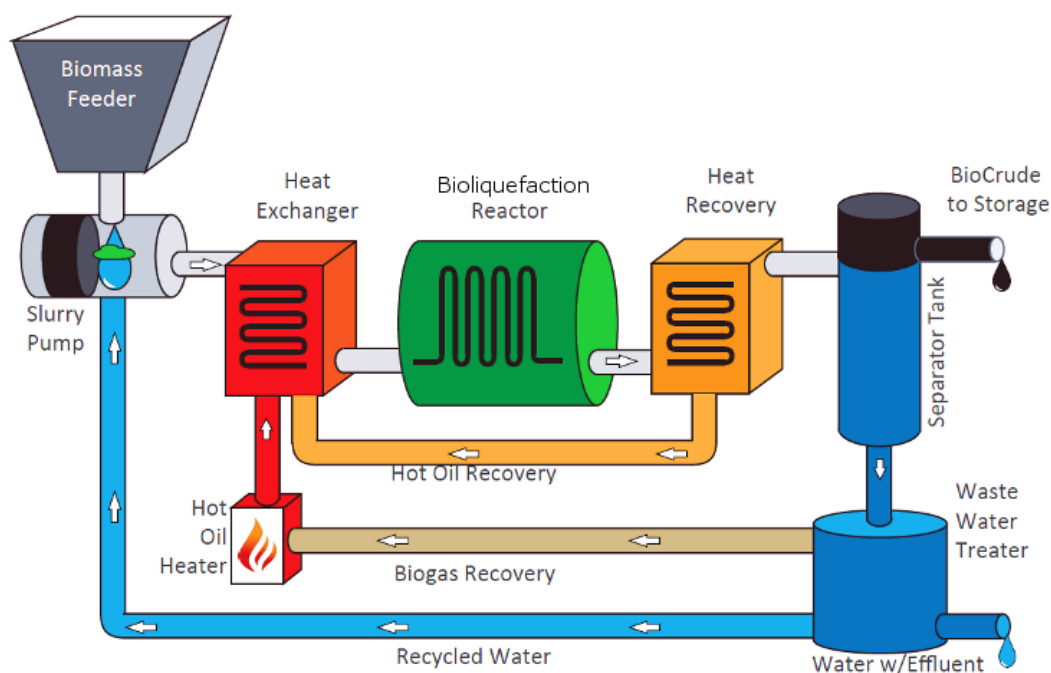

Treatment Concept

HTL is operated at higher temperatures compared to that of HTC. HTL is normally operated between 250°C and 400°C temperature, and a pressure of 30 bar to 250 bar. The biomass used as feedstock is almost completely liquefied in the process, and the product is a liquid product compared to the biochar produced in HTC.

Common applications

Sewage sludge, wet municipal solid waste (such as household organics made into a slurry).

Products and by-products

HTL produces a liquid biofuel.

Energy production

This liquid bio-oil product can then be upgraded and fractionated into products of use for the specific island nation, such as diesel, kerosene etc.

Hydrothermal Gasification (Supercritical Water Gasification)

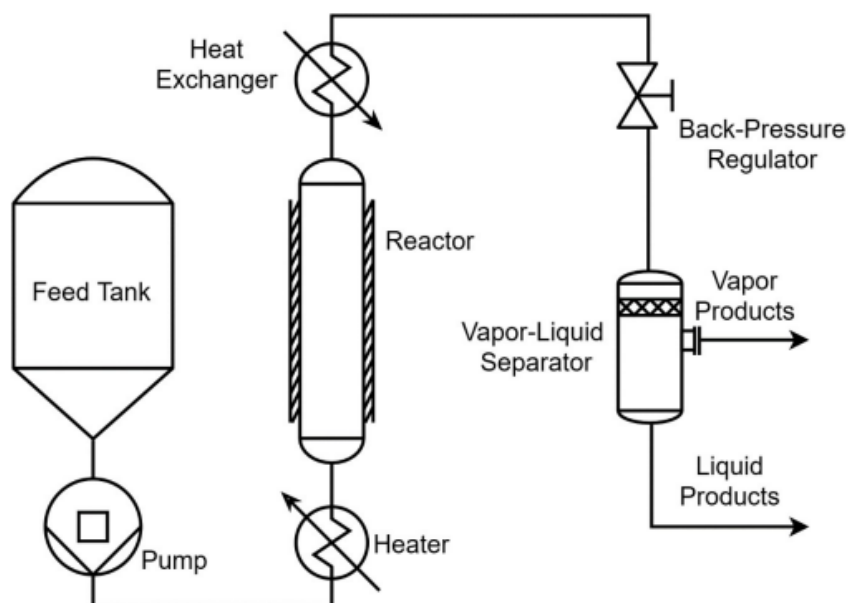

Treatment Concept	HTG is a form of gasification. It is also known as supercritical water gasification, as it is operated at temperatures and pressures above the critical point of water. HTG is operated at temperatures above 380°C, and pressures above 200 bar.
Common applications	Sewage sludge, wet municipal solid waste (such as household organics made into a slurry).
Products and by-products	HTG product is in a gaseous form, producing syngas (synthesis gas) which is mostly comprised of carbon monoxide and hydrogen.
Energy production	Syngas can then be cleaned and used as fuel, combusted, or converted to electricity using turbines.

Hydrothermal treatment is a relatively new technology and is thus far mostly only used in conjunction with wastewater treatment plants to treat sludge, as this is already in slurry form. For all types of hydrothermal treatment, the feedstock is required to be in slurry form with no more than 30% solids. This is for ease of pumping. However, high moisture content feed still requires dewatering prior to making the slurry, further increasing the energy requirements. Hydrothermal treatment as a WTE technology was deemed to have too many fatal flaws for use in PICs. With the composition of waste in PICs, this technology is unsuitable for available feedstocks.

Additionally, hydrothermal treatment is a relatively new technology, which has not had a significant amount of research and pilot plants established for conversion of municipal solid WTE. Therefore, this was also considered a fatal flaw as it is relatively new technology, rendering it inappropriate to implement in PICs. This is in addition to its feedstock requirements, which is most relevant to sludge treatment only. Whilst there is a growing requirement for innovative methods to treat sewage sludge in PICs with larger populations, hydrothermal technologies also have high energy and water input requirements.

Gasification (Plasma)

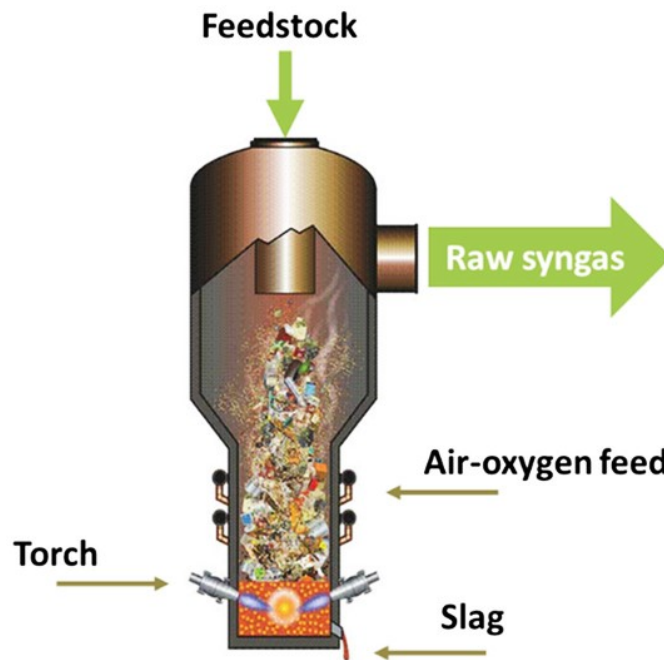

Treatment concept

Plasma gasification is quite different to direct and indirect gasification. A plasma torch powered by an electric arc is used to ionise gas and catalyse organic matter into syngas, whilst producing slag as a by-product. Compared to direct and indirect, plasma gasification is operated at much higher temperatures (about 1500°C) and is therefore a much more energy intensive process. However, plasma gasification also comes with greater benefits, with a conversion of biomass to syngas of more than 99%. Another great benefit of plasma gasification is that no sorting of the municipal solid waste feedstock is required, as plasma gasification could destroy and convert any substance (with the exception of nuclear waste). The first pilot scale plant for plasma gasification of municipal solid waste was built in Japan in the '90s, followed by additional more recent plants in India and Turkey.

Common applications

Anything except nuclear waste.

Products and by-products

Syngas, glassy slag.

Energy production

Syngas produces energy through combustion and can also be used in producing chemicals and liquid fuels. Similar to direct gasification, the syngas produced can be used in a gas turbine in order to produce electricity – however this means a higher operating pressure via a compressor for the use of a high-pressure turbine. Alternatively, the syngas could also be fuel upgraded as explained in direct gasification.

Gasification (Indirect)

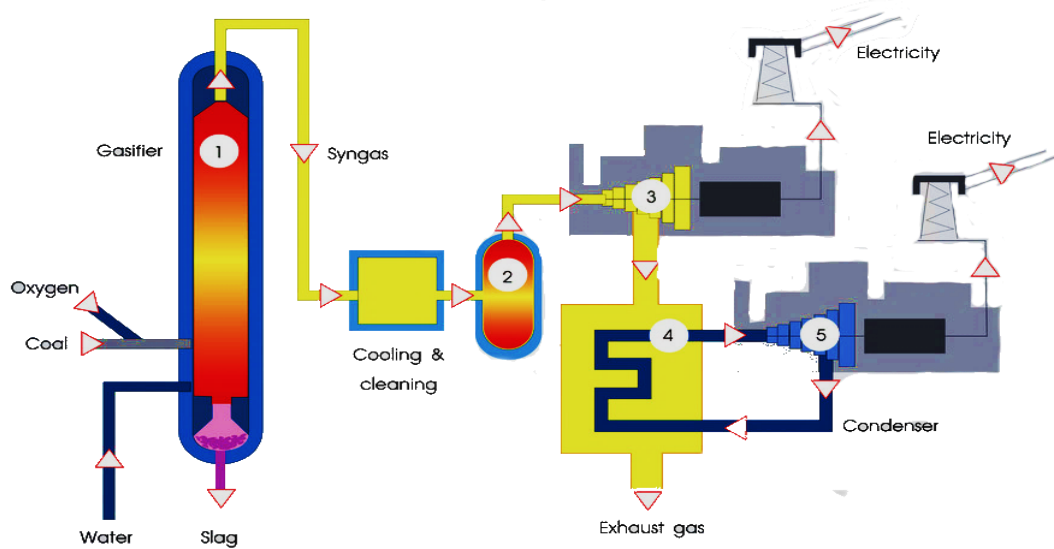

Treatment concept

Indirect gasification is where the feedstock is indirectly heated, using separate gasification and combustion chambers. Indirect gasification comprises of a heating medium, such as sand, which is circulated between the two chambers. As stated above, indirect gasification is operated at or near atmospheric pressure. The heating value of the syngas produced through indirect gasification is about two to three times higher than that of the heating value of syngas produced via direct gasification.

Common applications

Coal, wood chips, mixed MSW (requires drying).

Products and by-products

Slag, syngas.

Energy production

Syngas produces energy through combustion and can also be used in producing chemicals and liquid fuels. Similar to direct gasification, the syngas produced can be used in a gas turbine in order to produce electricity – however this means a higher operating pressure via a compressor for the use of a high-pressure turbine. Alternatively, the syngas could also be fuel upgraded as explained in direct gasification.

Continuously Stirred Tank Reactor Anaerobic Digestion

Continuous stirred tank reactors (CSTRs), also known as wet ADs, are digesters whose mixing regime is continuously mixed so that the solids content is low (TS less than 12%, which forms the liquid slurry). Mixing is continuous and is generally undertaken in vertical fully enclosed tanks. Settled heavy contaminants on the bottom of the digester will reduce the effective volume of the digester, reducing the effective capacity and therefore gas yield from the system. Light contaminants can also float to the surface of the digester and create a hard pan-like surface on the digester. This also reduces the effective volume of the digester and can impact the exchange of biogas to the gas collection system.

Upfront pre-processing would generally involve contaminant removal and preparation of the organics in a low-content slurry for the mixed digestion system, followed by dewatering of the dilute output from the digestate.

CSTR is well accepted as an effective AD system especially in the treatment of wastewater, high strength industrial effluents and slurry like feedstocks such as digestate or biosolids. These systems are generally highly sophisticated and complex, with tightly controlled operating regimes. Mixing can take place through either pump mixing, gas mixing, or mechanical mixing using stirrers (as depicted below). Higher biogas generation is often the key objective and is an important factor to justify the large investment of these enhanced AD systems. Given the technological complexity and the limitations on feedstock, this was viewed as fatally flawed for the Pacific Islands context.

Continuously Stirred Tank Reactor (CSTR) Anaerobic Digestion Technology

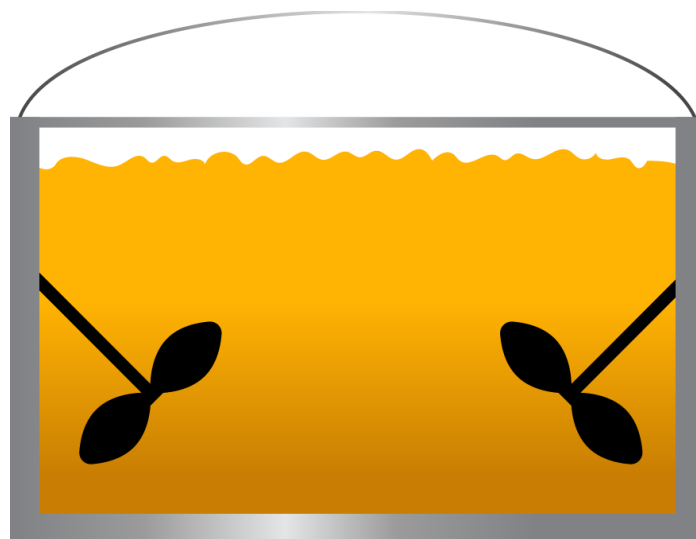

Treatment concept	A completely mixed form of anaerobic reactor aimed at maximising waste and biomass contact and optimizing digestion performance. A popular configuration that suits a wide range of feedstock and biomass retention technology. Mixing is achieved through feedstock movement (e.g., waste enters from the bottom and leaves at the top), mechanical stirrers, or jet mixers (recirculated biogas gas).
Common applications	Wastewater treatment.
By-products	Effluent, digestate and biogas.
Energy production	Methane gas and electricity.

Upflow Anaerobic Sludge Blanket (UASB) Anaerobic Digestion

UASB is also a well-accepted system, especially in the treatment of wastewater, high strength industrial effluents and slurry like feedstock such as digestate or biosolids. These systems are generally more sophisticated and complex, comprising controlled operating regimes, various mixing mechanisms and with added baffle and biomass retention for the UASB reactors. Higher biogas generation is its objective and is an important factor to justify the large investment of these enhanced AD systems.

Upflow Anaerobic Sludge Blanket (UASB) Anaerobic Digestion Technology

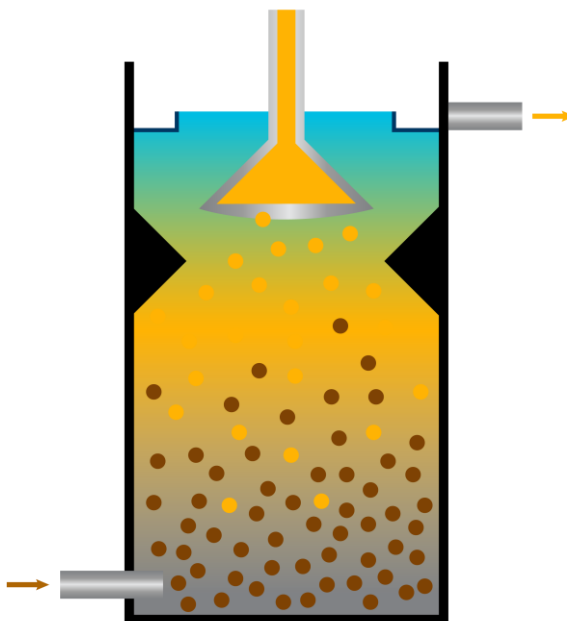

Treatment concept	In an UASB reactor, a sludge blanket is retained within the system. Granular anaerobic sludge is suspended in the bottom of the reactor, with feedstock flowing through from the bottom in an up-flow movement and digestate flows out from the top of the reactor. The retention of biomass in a UASB system allows for a higher organic loading rate, shorter retention times and general stability of the process.
Common applications	Wastewater treatment.
By-products	Effluent, digestate and biogas.
Energy production	Methane gas and electricity.

Mechanical treatment

WästAway is one technology case study that can provide an overview of the type of process used to produce refuse-derived fuel (RDF). WästAway produces a pelletised fuel to be used as feedstock in the production of biofuels, or to be used as soil fertiliser. The technology has been used for over ten years, meaning it is a well-established technology. The technology processes and sterilises waste, removing any remaining recyclable materials, and converts it to its end-product.

The entire process is completed in less than half an hour, converting the MSW into 'Fluff', an inert, odourless, pathogen-free product, that has a range of possible uses. This 'Fluff' can then be pelletised for use as a coal substitute for power plants. The technology extracts ferrous and non-ferrous metals, glass, ceramics, dirt, and sand from household MSW, then processes the remaining waste to create 'Fluff'.

The technology can process unsorted MSW, with materials entering a pre-shredder prior to a process line where ferrous material and aluminum is removed for recycling, along with inert materials such as glass and stone. Remaining organic rich material is then further shredded and enters a hydrolyser for sterilisation. Textiles are then removed for further processing and are refined. Finally, all material enters a dryer for drying and can then either be used as 'Fluff' or pelletised, cooled, and ready for use.



